



PEMERINTAH KABUPATEN WAY KANAN
DINAS PEKERJAAN UMUM

Komplek Pemda Way Kanan, Blambangan Umpu

GAMBAR RENCANA

PEKERJAAN :

PEMELIHARAAN JALAN SP. WAY TUA ASRI - WAY TUBA ASRI
KEC. WAY TUBA

KAB. WAY KANAN
TAHUN 2022

KONSULTAN PERENCANA :

CV. TRIJAYA WASKITA



PETA JARINGAN JALAN KABUPATEN WAY KANAN

DINAS PEKERJAAN UMUM
Jalan Widana Tahir Hasan Komplek Perkantoran Pemda Way Kanan Km.2
Belambanga Umpu

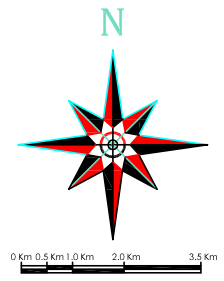

LEGENDA

- JALAN NASIONAL
- JALAN PROPINSI
- JALAN KABUPATEN
- JALAN LINGKUNGAN
- JALAN KERETA
- BATAS PROPINSI
- BATAS KABUPATEN
- BATAS KECAMATAN
- SUNGAI
- ☐ IBU KOTA KABUPATEN
- IBU KOTA KECAMATAN
- 🚂 STASIUN
- 001 NOMOR RUAS JALAN KABUPATEN
- 048 P NOMOR RUAS JALAN NASIONAL/PROPINSI



Datum WGS 84
 Sistem Proyeksi Peta Universal Transverse Mercator (UTM)
 Sistem Grid Graticule

Sumber Data :
 Peta ini disusun dari pengukuran lapangan
 Peta Jaringan Jalan Tahun 2008

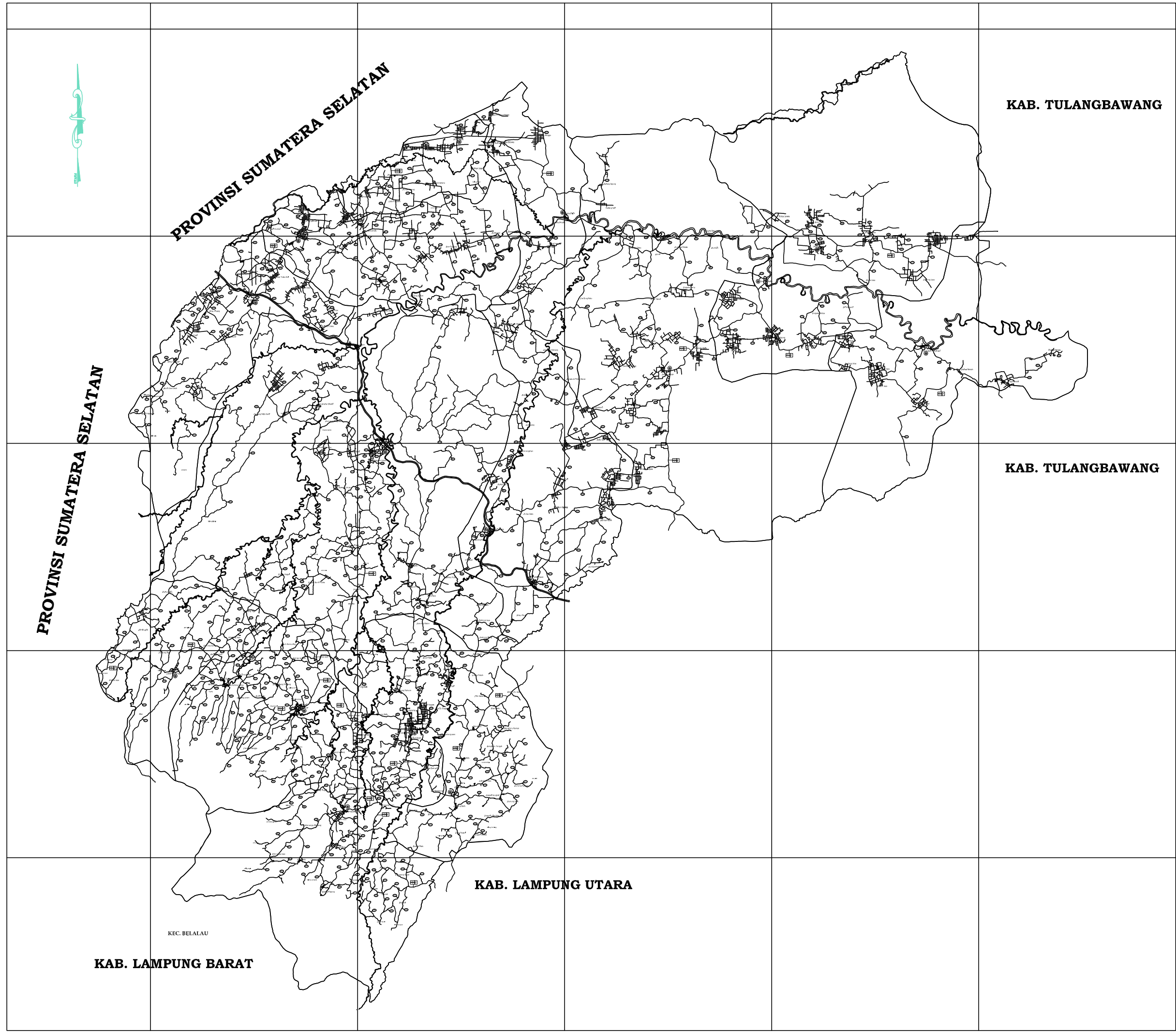

PROVINSI SUMATERA SELATAN

PROVINSI SUMATERA SELATAN

KAB. TULANGBAWANG

KAB. TULANGBAWANG

KAB. LAMPUNG UTARA

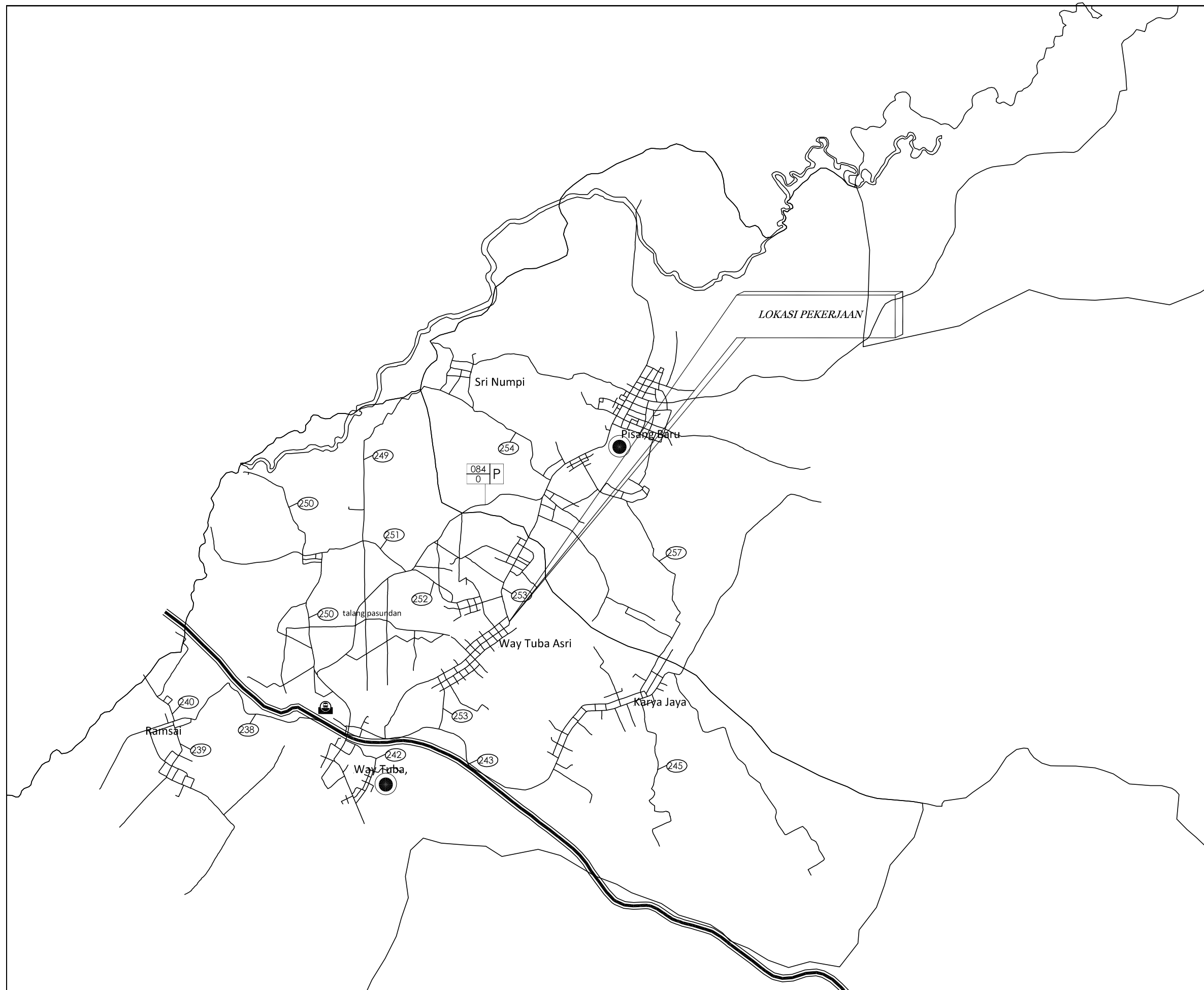

KAB. LAMPUNG BARAT

KEC. BELALAU



PEMERINTAH KABUPATEN WAY KANAN
DINAS PEKERJAAN UMUM
 Komplek Pemda Kabupaten Way Kanan

LEGENDA

-  = Pemukiman
-  = Gorong-gorong
-  = Jembatan

KEGIATAN

PERENCANAAN JALAN APBD 2019
 KEC. WAY TUBA II

PEKERJAAN

PENINGKATAN JALAN BRINGIN JAYA - SAY UMPU
 KEC. WAY TUBA

KAMPUNG : BRINGIN JAYA

KECAMATAN : WAY TUBA

KABUPATEN : WAY KANAN

PROPINSI : LAMPUNG

GAMBAR

SITUASI
 MEMANJANG

PERENCANA

CV. WAHANA PRATAMA AGARTHA KONSULTAN

DIKETAHUI

 IBRAMSYAH
 DIREKTUR

DIGAMBAR

 YANA SOPIAN, ST
 DRAFTER

DIRENCANA

 MUNAWAR HOLID, ST
 TITAN LEADER

DIPERIKSA

Pejabat Pelaksana Teknis Kegiatan (PPTK)
 Dinas Pekerjaan Umum
 Kab. Way Kanan

ACHMAD DINAN AGUSTIAN, ST
 NIP. 19760818 200902 1 003

MENYETUJUI

Pejabat Pembuat Komitmen (PPK)
 Dinas Pekerjaan Umum
 Kab. Way Kanan



ROMI FERIZAL, ST, MT
 NIP. 19790223 200604 1 005

SKALA	NO. LEMBAR	JUMLAH LEMBAR
-------	------------	---------------

1 : 1.000	-	-
1 : 100	-	-

Potongan Memanjang

LEGENDA

-  = Pemukiman
-  = Gorong-gorong
-  = Jembatan

KEGIATAN

PEKERJAAN

PEMELIHARAAN JALAN SP. WAY TUBA ASRI - WAY TUBA ASRI
KEC. WAY TUBA

KAMPUNG : WAY TUBA ASRI

KECAMATAN : WAY TUBA

KABUPATEN : WAY KANAN

PROPINSI : LAMPUNG

GAMBAR

SITUASI
MEMANJANG

KONSULTAN PERENCANA

CV. TRIJAYA WASKITA

ENDAH PRAPTINI, ST
TEAM LEADER

DIGAMBAR

DIRENCANA

YOPI FAJRI
DRAFTER



RIA WIRADESA, ST
TEAM LEADER

SKALA NO. LEMBAR JUMLAH LEMBAR

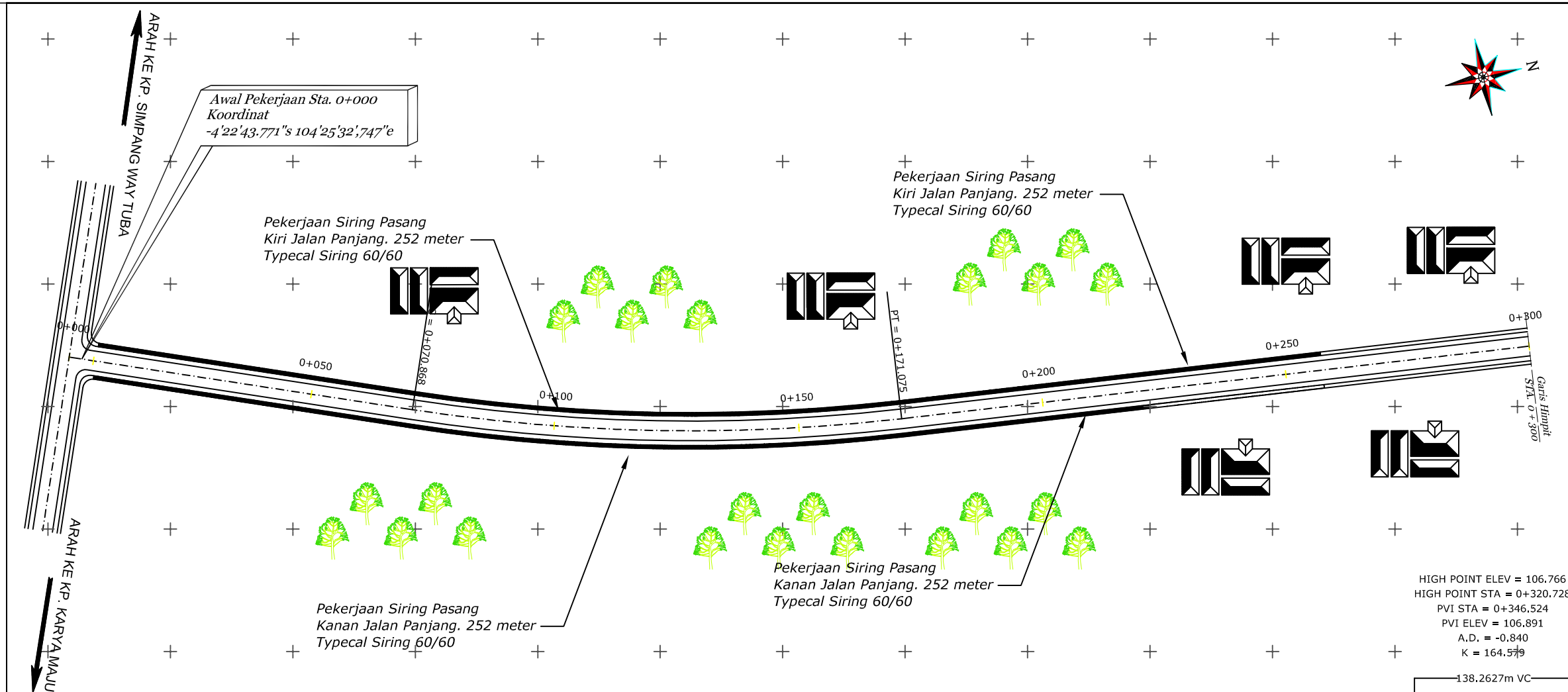

1 : 1.000
1 : 100

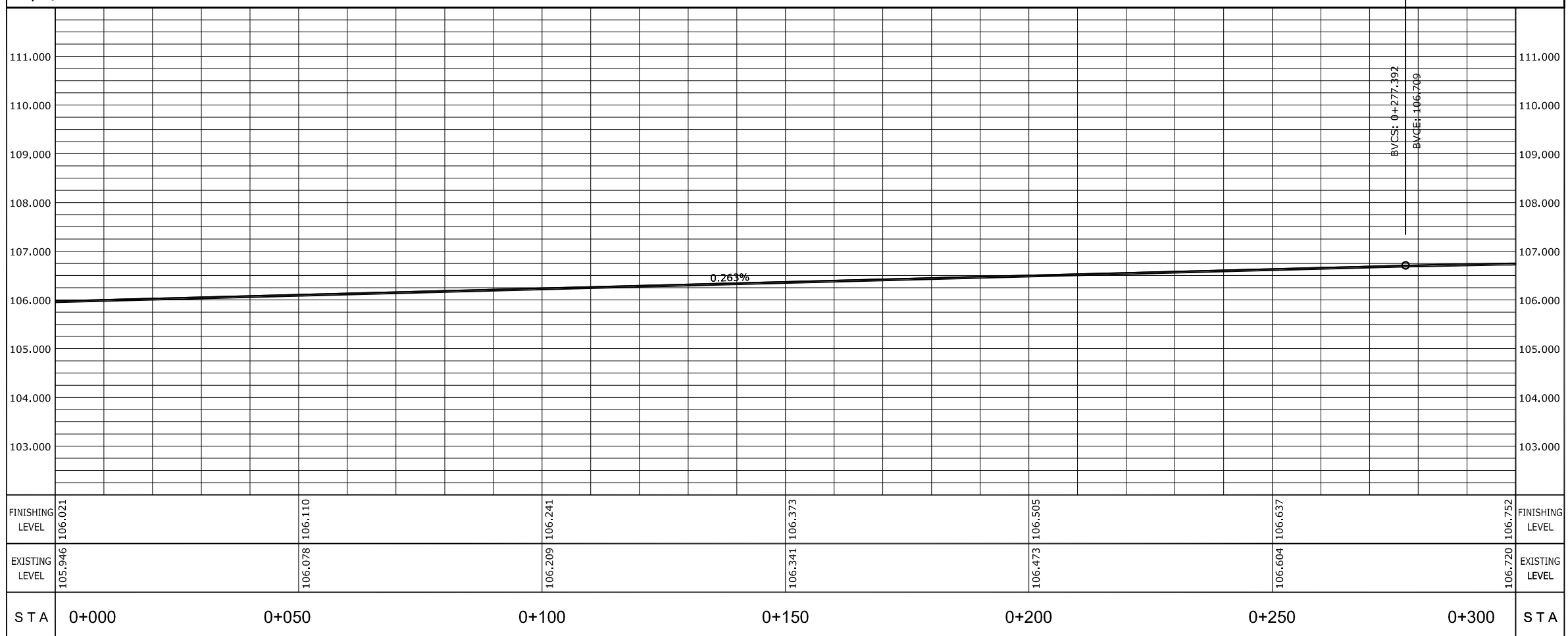

HIGH POINT ELEV = 106.766
 HIGH POINT STA = 0+320.728
 PVI STA = 0+346.524
 PVI ELEV = 106.891
 A.D. = -0.840
 K = 164.579



LEGENDA

-  = Pemukiman
-  = Gorong-gorong
-  = Jembatan

KEGIATAN

PEKERJAAN

PEMELIHARAAN JALAN SP. WAY TUBA ASRI - WAY TUBA ASRI
KEC. WAY TUBA

KAMPUNG : WAY TUBA ASRI

KECAMATAN : WAY TUBA

KABUPATEN : WAY KANAN

PROPINSI : LAMPUNG

GAMBAR

SITUASI
MEMANJANG

KONSULTAN PERENCANA
CV. TRIJAYA WASKITA

ENDAH PRAPTINI, ST
TEAM LEADER

DIGAMBAR

DIRENCANA

YOPI FAJRI
DRAFTER

RIA WIRADESA, ST
TEAM LEADER

SKALA NO. LEMBAR JUMLAH LEMBAR

1 : 1.000
1 : 100

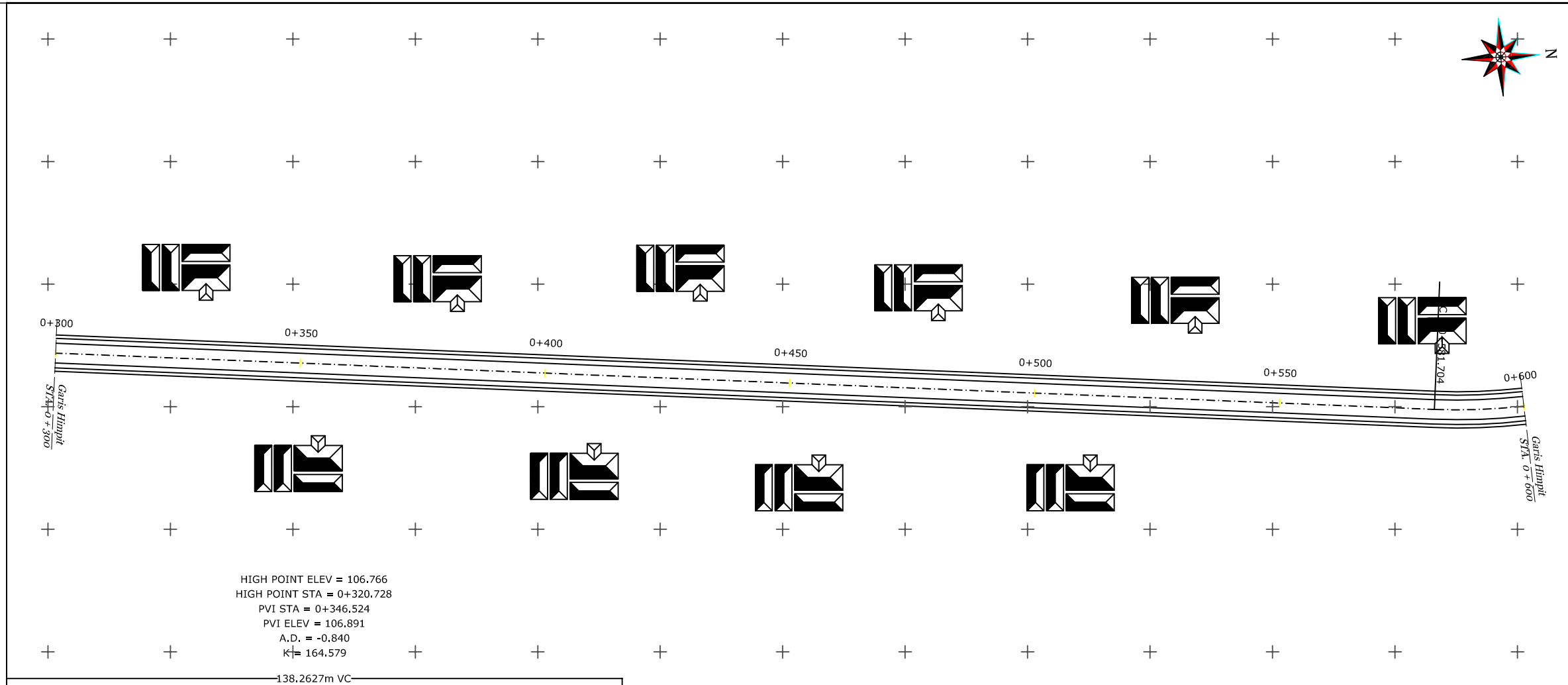

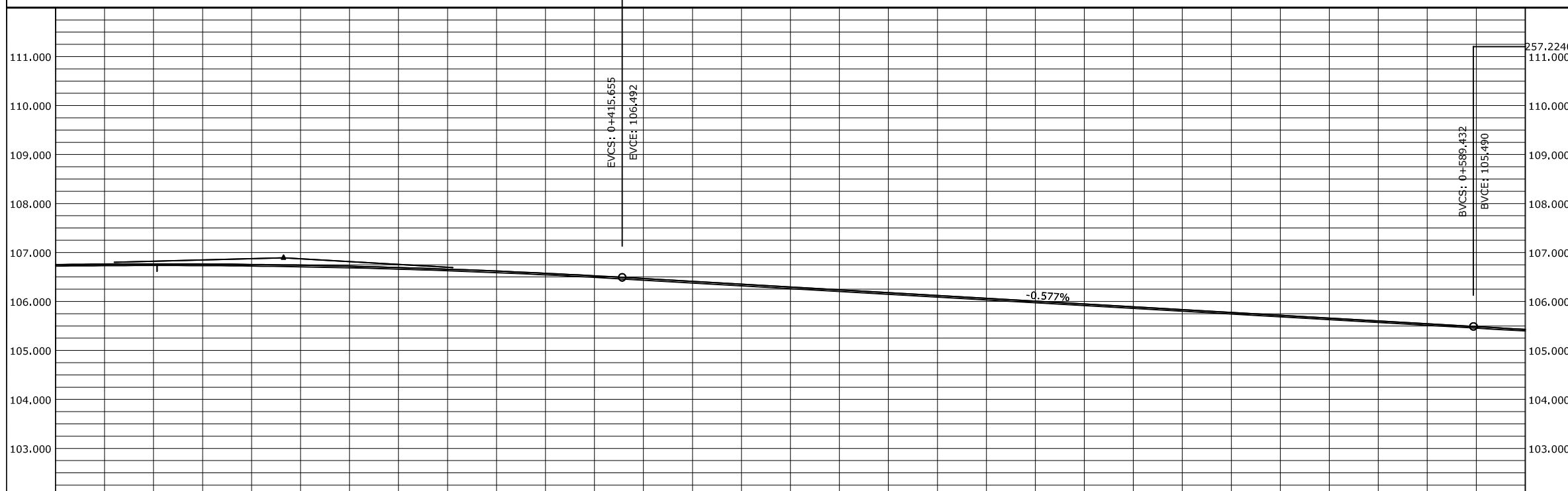

HIGH POINT ELEV = 106.766
 HIGH POINT STA = 0+320.728
 PVI STA = 0+346.524
 PVI ELEV = 106.891
 A.D. = -0.840
 K = 164.579

138.2627m VC



STA	0+300	0+350	0+400	0+450	0+500	0+550	0+600	STA
FINISHING LEVEL	106.752	106.740	106.574	106.294	106.005	105.717	105.430	FINISHING LEVEL
EXISTING LEVEL	106.720	106.707	106.542	106.262	105.973	105.685	105.398	EXISTING LEVEL

LEGENDA

-  = Pemukiman
-  = Gorong-gorong
-  = Jembatan

KEGIATAN

PEKERJAAN

PEMELIHARAAN JALAN SP. WAY TUBA ASRI - WAY TUBA ASRI
KEC. WAY TUBA

KAMPUNG : WAY TUBA ASRI

KECAMATAN : WAY TUBA

KABUPATEN : WAY KANAN



PROPINSI : LAMPUNG

GAMBAR

SITUASI
MEMANJANG

KONSULTAN PERENCANA
CV. TRIJAYA WASKITA



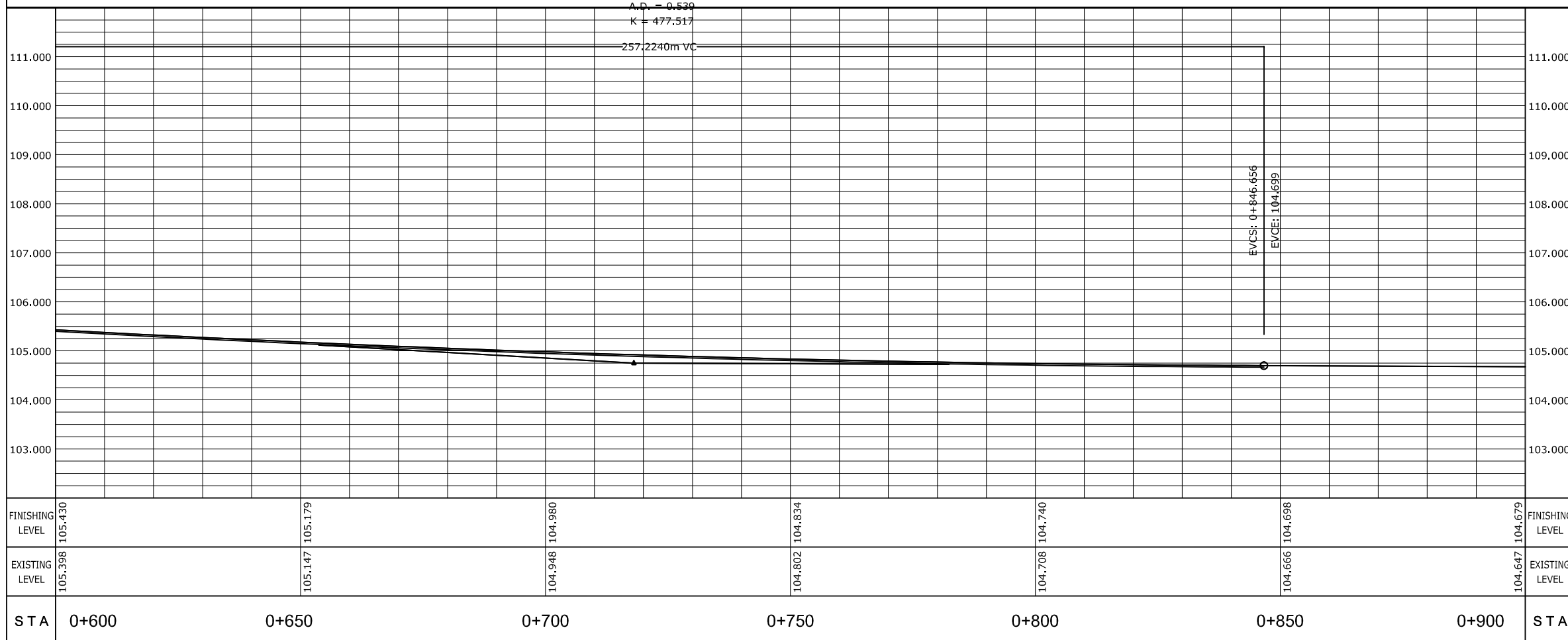
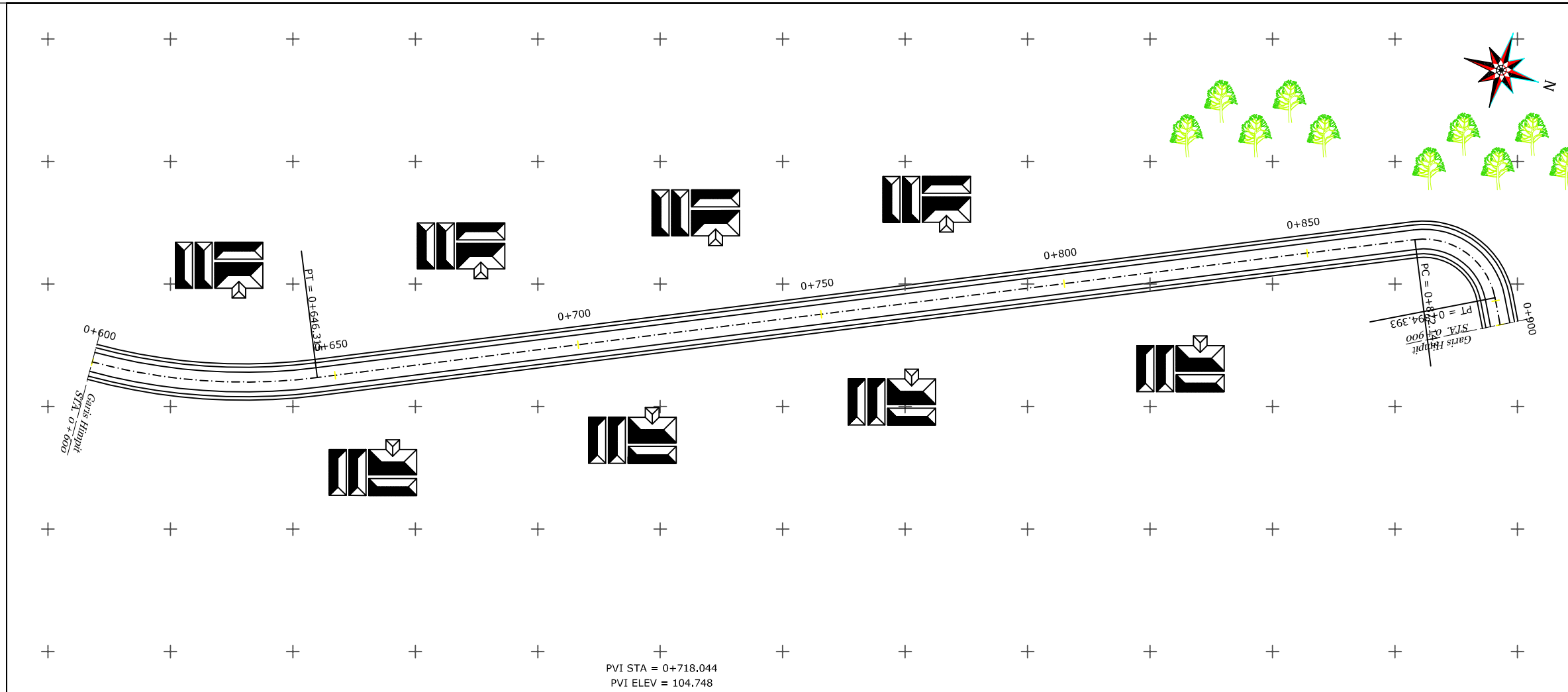

ENDAH PRAPTINI, ST
TEAM LEADER

DIGAMBAR  YOPI FAJRI DRAFTER	DIRENCANA  RIA WIRADESA, ST TEAM LEADER
--	---

SKALA	NO. LEMBAR	JUMLAH LEMBAR
1 : 1.000 1 : 100	-	-



LEGENDA

-  = Pemukiman
-  = Gorong-gorong
-  = Jembatan

KEGIATAN

PEKERJAAN

PEMELIHARAAN JALAN SP. WAY TUBA ASRI - WAY TUBA ASRI
KEC. WAY TUBA

KAMPUNG : WAY TUBA ASRI

KECAMATAN : WAY TUBA

KABUPATEN : WAY KANAN

PROPINSI : LAMPUNG

GAMBAR

SITUASI
MEMANJANG

KONSULTAN PERENCANA
CV. TRIJAYA WASKITA

ENDAH PRAPTINI, ST
TEAM LEADER

DIGAMBAR

YOPI FAJRI
DRAFTER

DIRENCANA



RIA WIRADESA, ST
TEAM LEADER

SKALA NO. LEMBAR JUMLAH LEMBAR

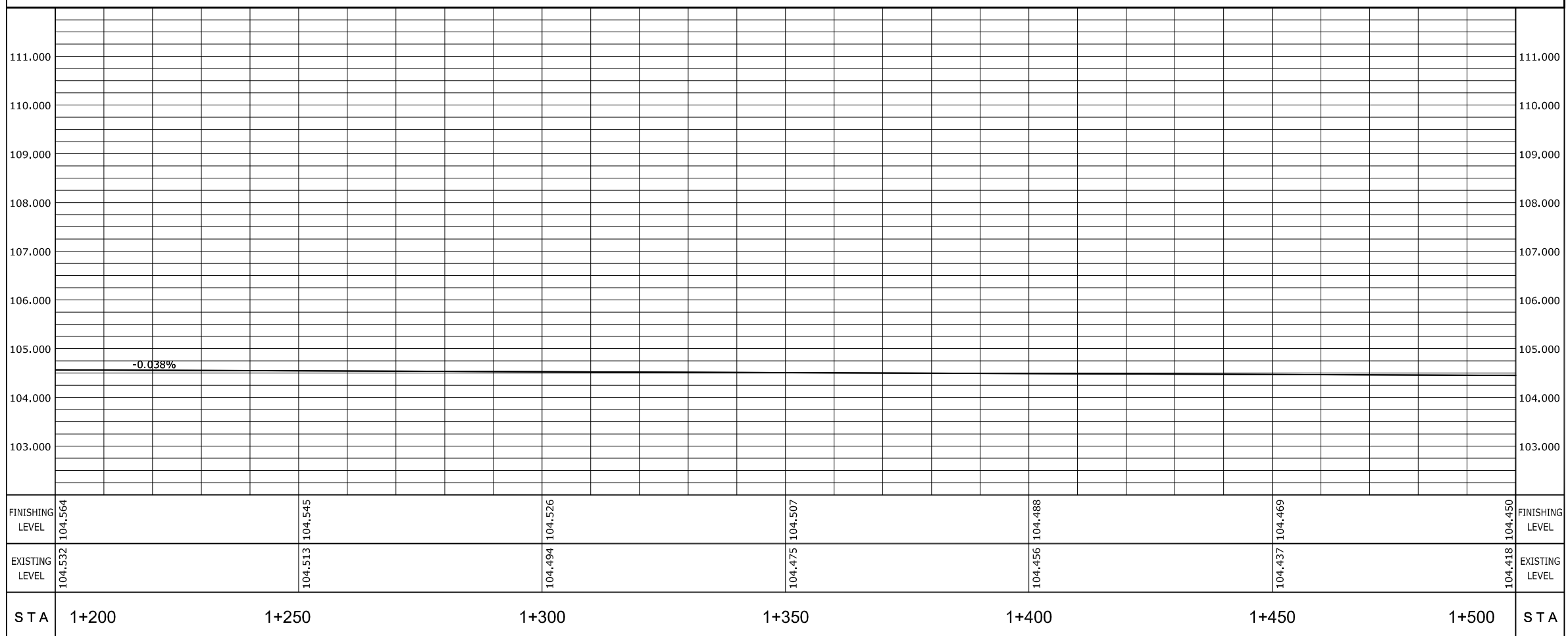
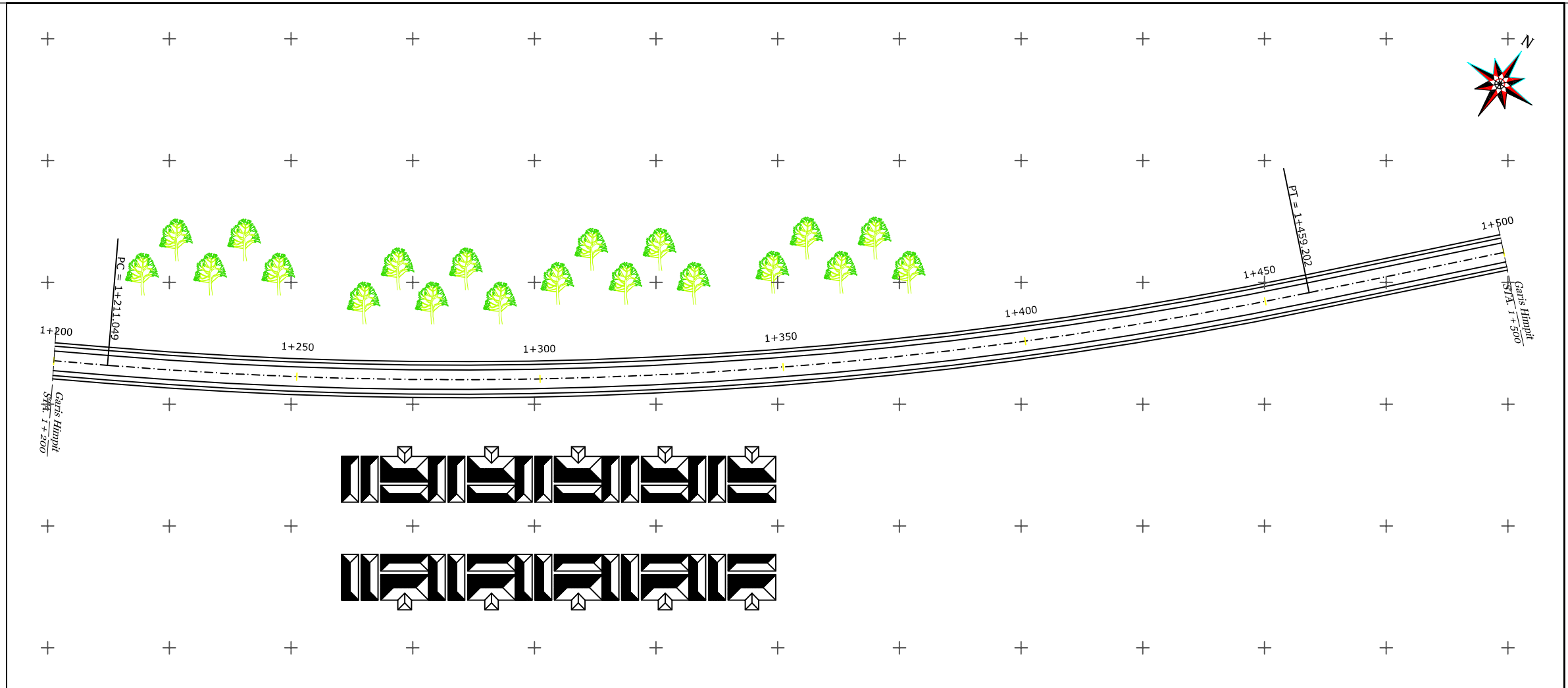
1 : 1.000
1 : 100



LEGENDA

-  = Pemukiman
-  = Gorong-gorong
-  = Jembatan

KEGIATAN

PEKERJAAN

PEMELIHARAAN JALAN SP. WAY TUBA ASRI - WAY TUBA ASRI
KEC. WAY TUBA

KAMPUNG : WAY TUBA ASRI

KECAMATAN : WAY TUBA

KABUPATEN : WAY KANAN



PROPINSI : LAMPUNG

GAMBAR

SITUASI
MEMANJANG

KONSULTAN PERENCANA
CV. TRIJAYA WASKITA



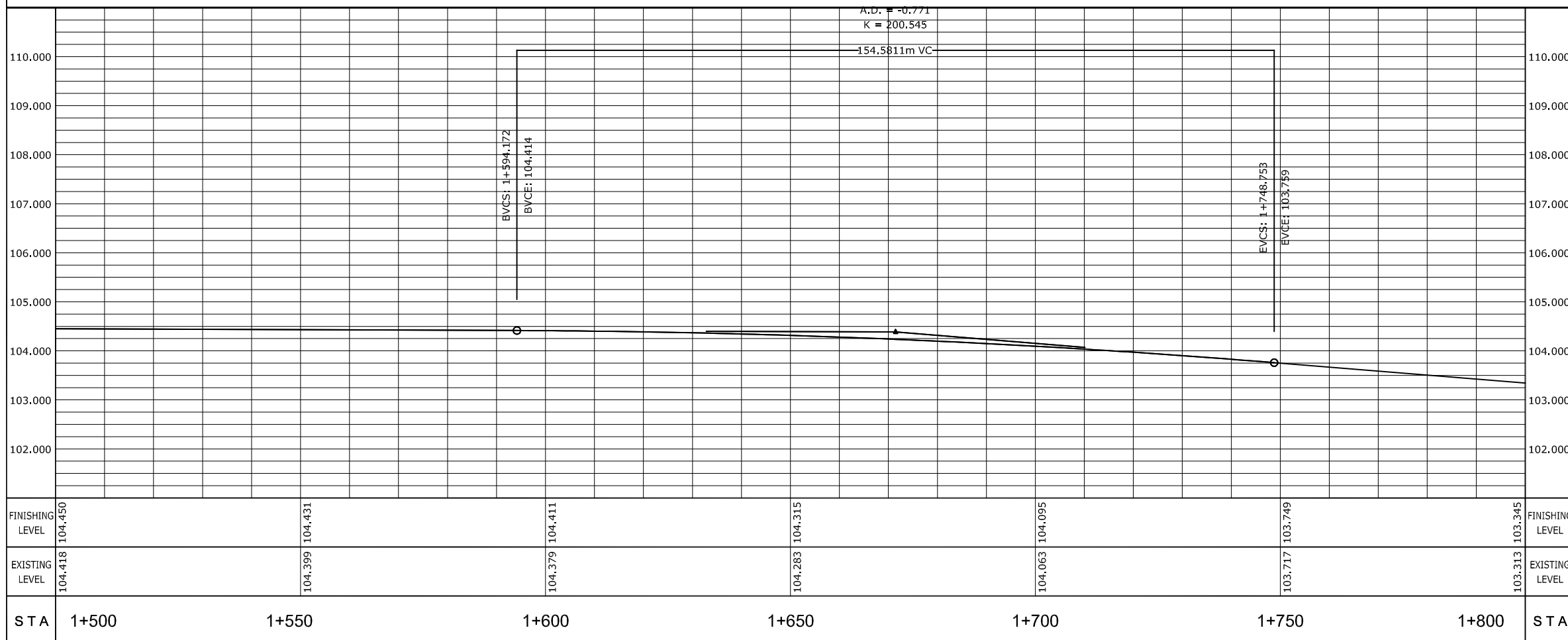
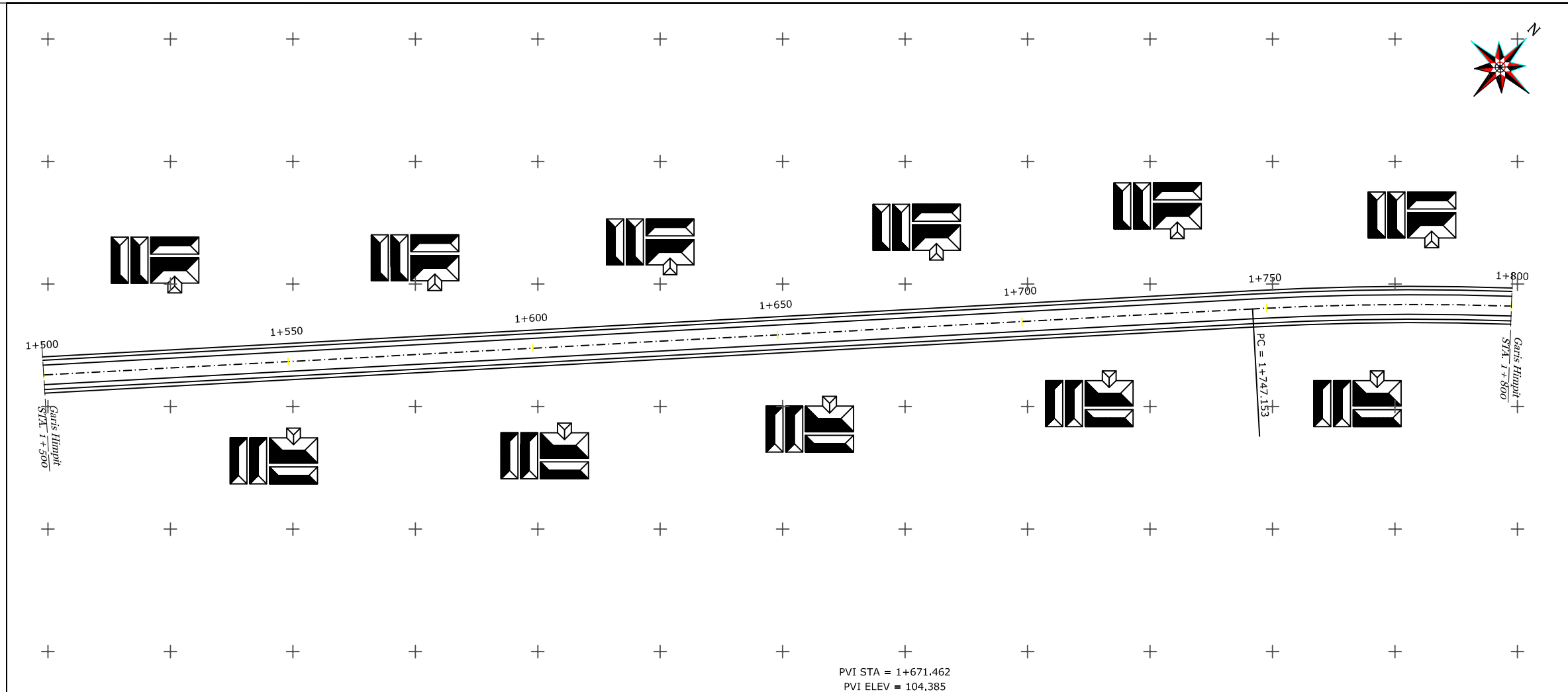

ENDAH PRAPTINI, ST
TEAM LEADER

DIGAMBAR  YOPI FAJRI DRAFTER	DIRENCANA  RIA WIRADESA, ST TEAM LEADER
--	---

SKALA	NO. LEMBAR	JUMLAH LEMBAR
1 : 1.000 1 : 100	-	-



LEGENDA

-  = Pemukiman
-  = Gorong-gorong
-  = Jembatan

KEGIATAN

PEKERJAAN

PEMELIHARAAN JALAN SP. WAY TUBA ASRI - WAY TUBA ASRI
KEC. WAY TUBA

KAMPUNG : WAY TUBA ASRI

KECAMATAN : WAY TUBA

KABUPATEN : WAY KANAN

PROPINSI : LAMPUNG

GAMBAR

SITUASI
MEMANJANG

KONSULTAN PERENCANA
CV. TRIJAYA WASKITA



ENDAH PRAPTINI, ST
TEAM LEADER

DIGAMBAR

YOPI FAJRI
DRAFTER

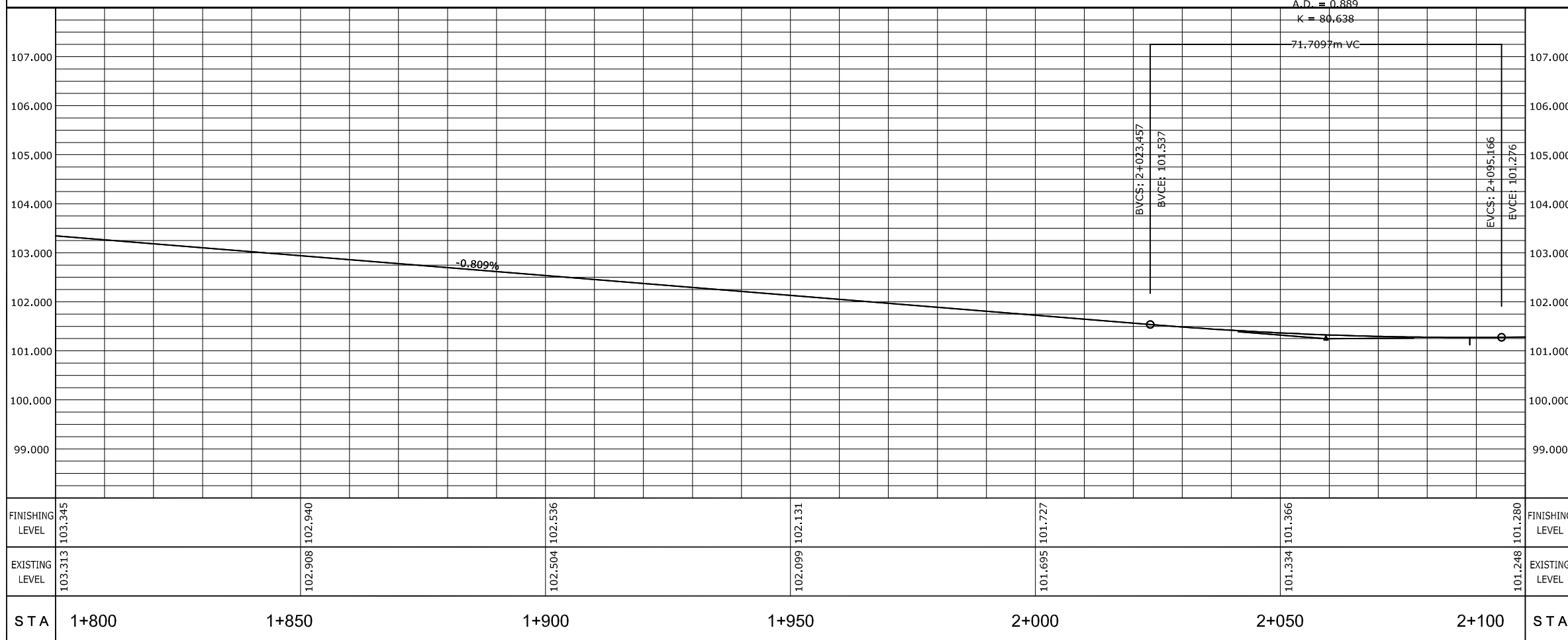
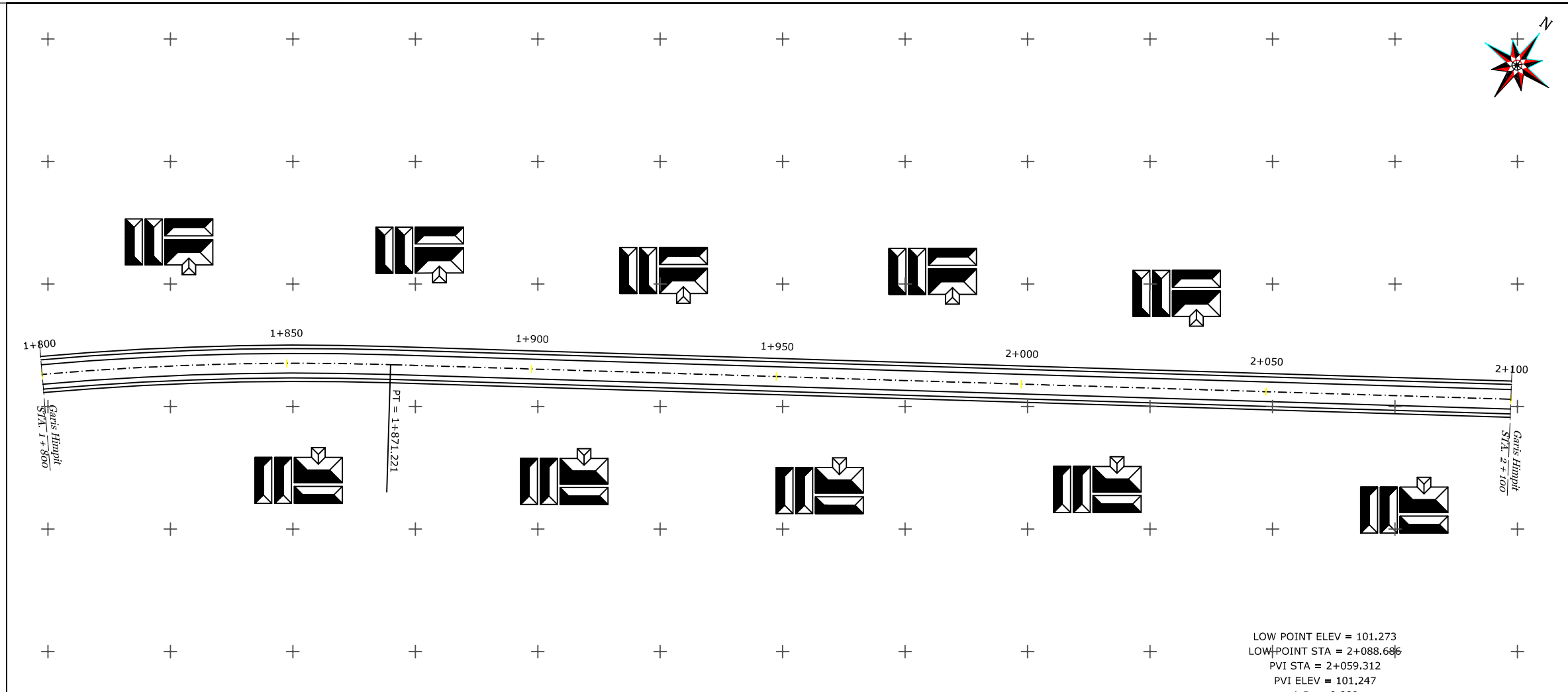

DIRENCANA

RIA WIRADESA, ST
TEAM LEADER

SKALA	NO. LEMBAR	JUMLAH LEMBAR
1 : 1.000 1 : 100	-	-



LEGENDA

-  = Pemukiman
-  = Gorong-gorong
-  = Jembatan

KEGIATAN

PEKERJAAN

PEMELIHARAAN JALAN SP. WAY TUBA ASRI - WAY TUBA ASRI
KEC. WAY TUBA

KAMPUNG : WAY TUBA ASRI

KECAMATAN : WAY TUBA

KABUPATEN : WAY KANAN



PROPINSI : LAMPUNG

GAMBAR

SITUASI
MEMANJANG

KONSULTAN PERENCANA
CV. TRIJAYA WASKITA



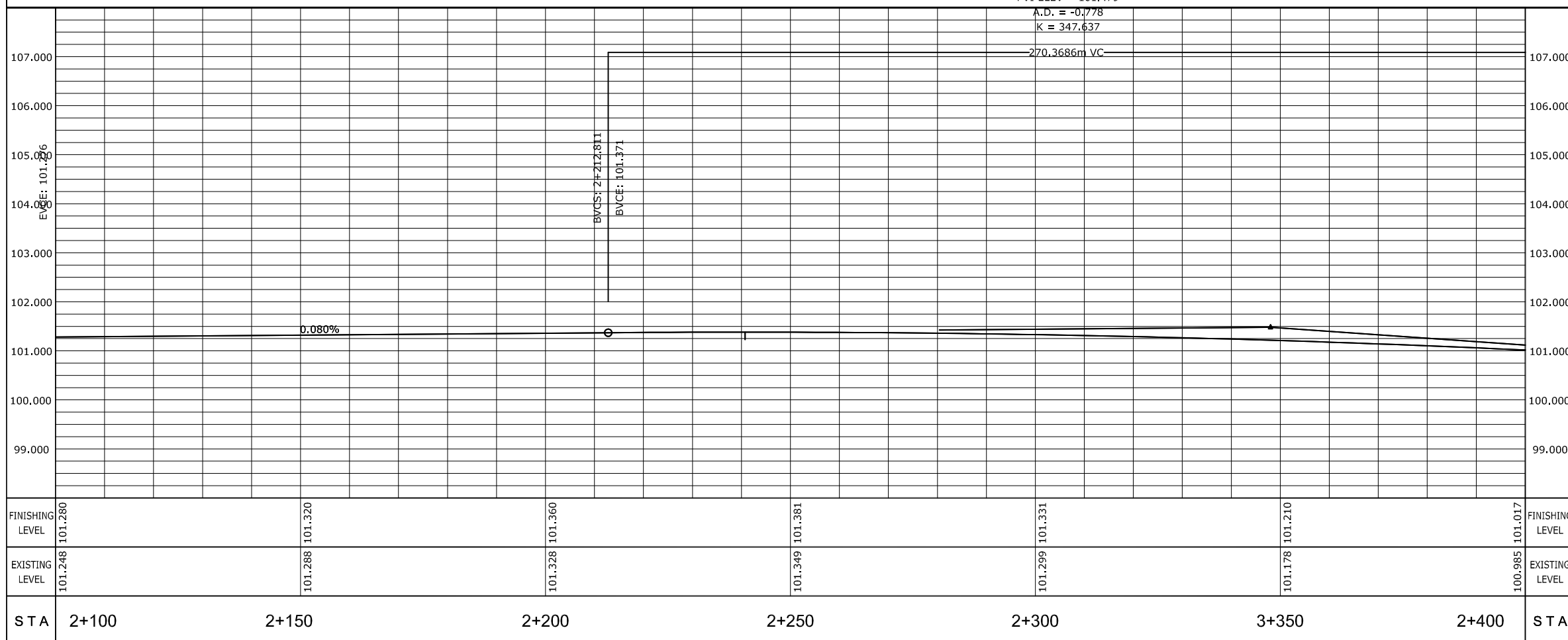
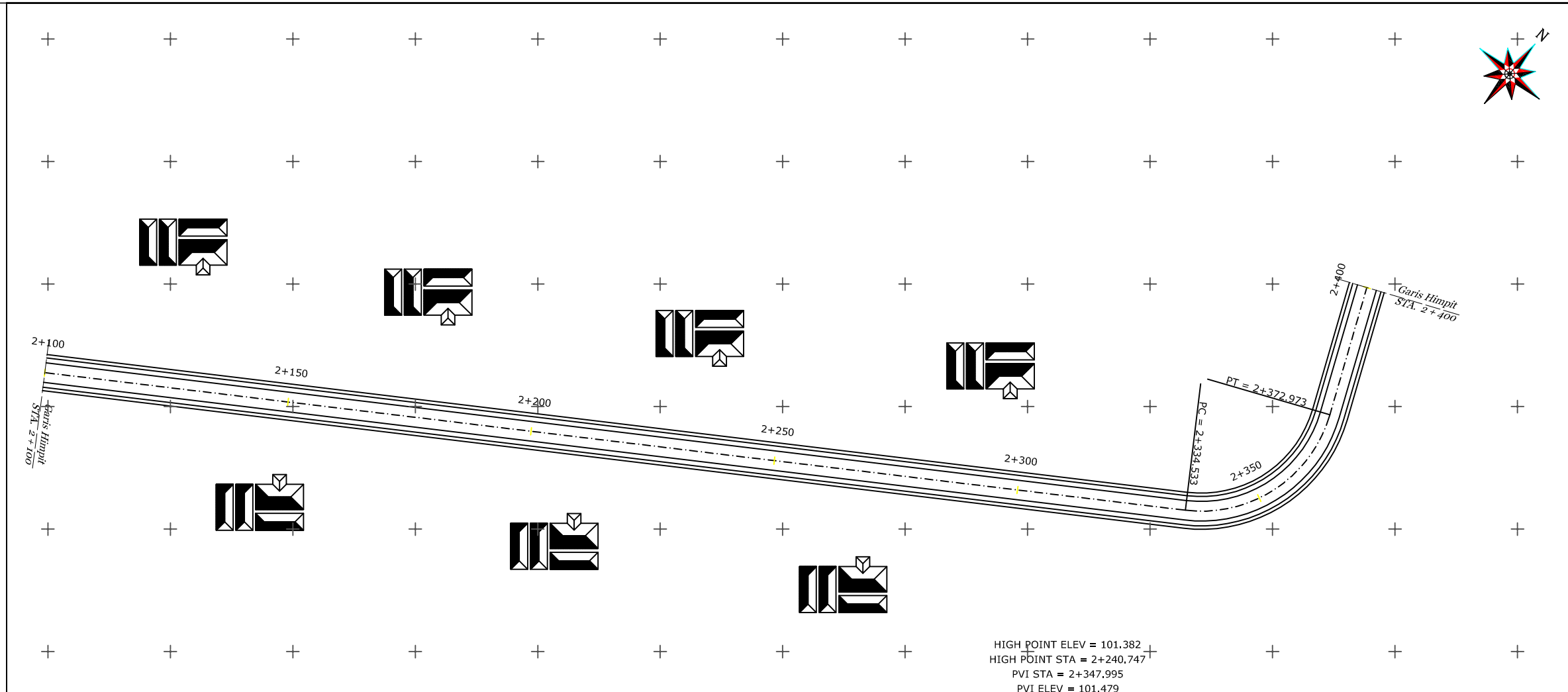

ENDAH PRAPTINI, ST
TEAM LEADER

DIGAMBAR  YOPI FAJRI DRAFTER	DIRENCANA  RIA WIRADESA, ST TEAM LEADER
--	---

SKALA	NO. LEMBAR	JUMLAH LEMBAR
1 : 1.000 1 : 100	-	-



LEGENDA

-  = Pemukiman
-  = Gorong-gorong
-  = Jembatan

KEGIATAN

PEKERJAAN

PEMELIHARAAN JALAN SP. WAY TUBA ASRI - WAY TUBA ASRI
KEC. WAY TUBA

KAMPUNG : WAY TUBA ASRI

KECAMATAN : WAY TUBA

KABUPATEN : WAY KANAN

PROPINSI : LAMPUNG

GAMBAR

SITUASI
MEMANJANG

KONSULTAN PERENCANA
CV. TRIJAYA WASKITA

ENDAH PRAPTINI, ST
TEAM LEADER

DIGAMBAR

YOPI FAJRI
DRAFTER



DIRENCANA

RIA WIRADESA, ST
TEAM LEADER

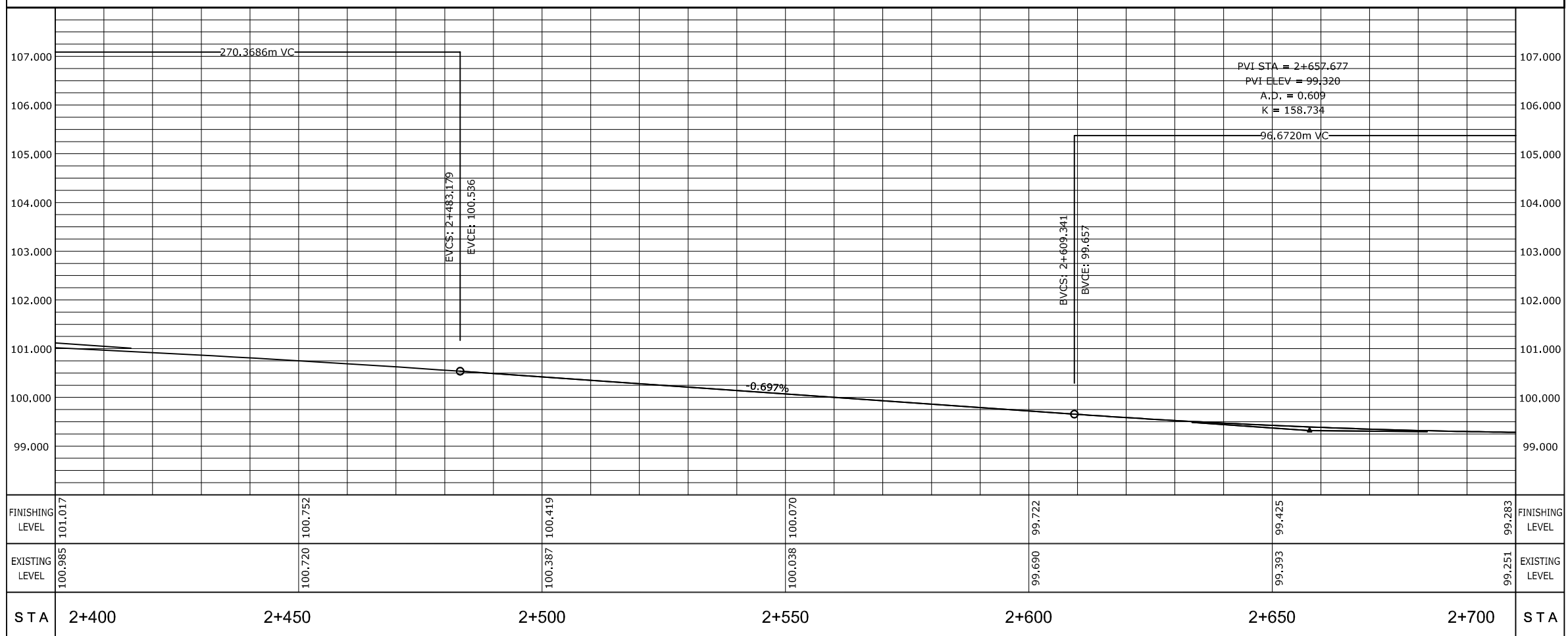
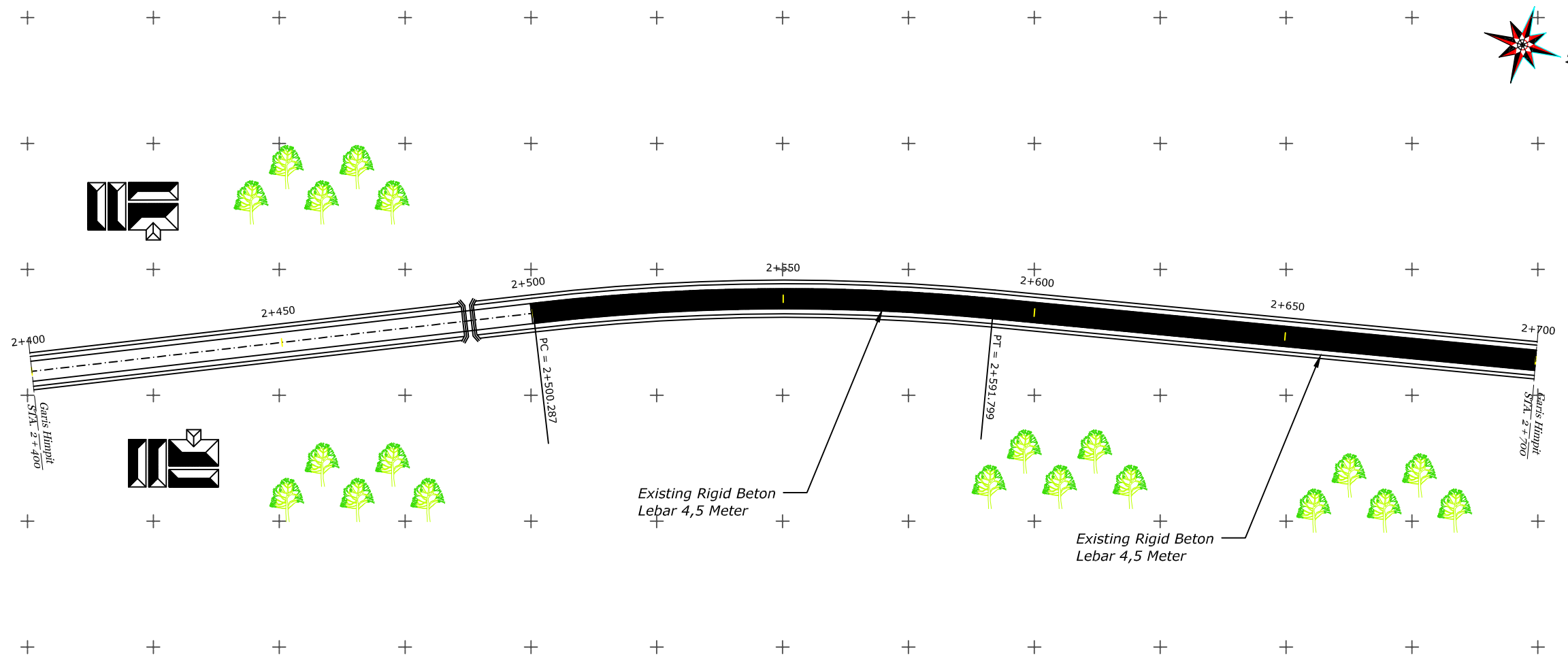
SKALA NO. LEMBAR JUMLAH LEMBAR

1 : 1.000
1 : 100



LEGENDA

-  = Pemukiman
-  = Gorong-gorong
-  = Jembatan

KEGIATAN

PEKERJAAN

PEMELIHARAAN JALAN SP. WAY TUBA ASRI - WAY TUBA ASRI
KEC. WAY TUBA

KAMPUNG : WAY TUBA ASRI

KECAMATAN : WAY TUBA

KABUPATEN : WAY KANAN

PROPINSI : LAMPUNG

GAMBAR

SITUASI
MEMANJANG

KONSULTAN PERENCANA

CV. TRIJAYA WASKITA

ENDAH PRAPTINI, ST
TEAM LEADER

DIGAMBAR

DIRENCANA

YOPI FAJRI
DRAFTER



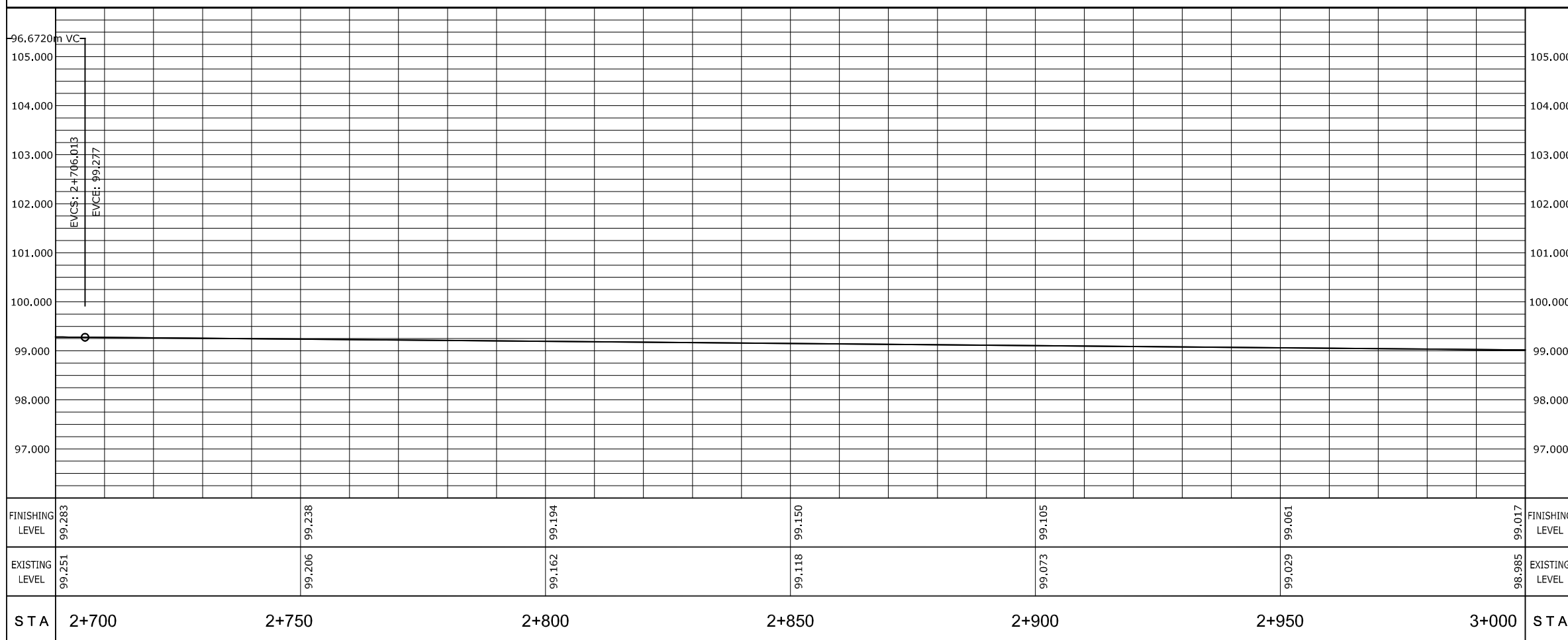
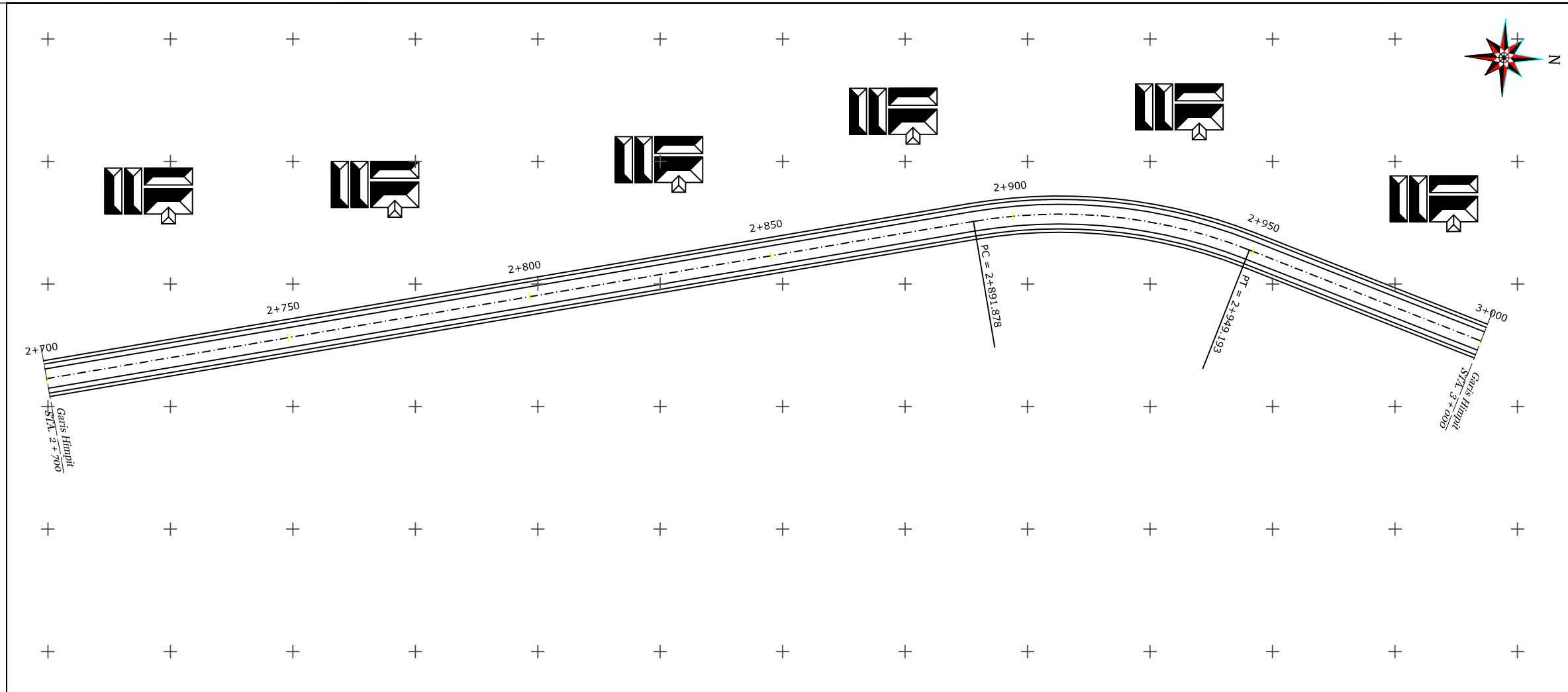

RIA WIRADESA, ST
TEAM LEADER

SKALA NO. LEMBAR JUMLAH LEMBAR

1 : 1.000
1 : 100



LEGENDA

-  = Pemukiman
-  = Gorong-gorong
-  = Jembatan

KEGIATAN

PEKERJAAN

PEMELIHARAAN JALAN SP. WAY TUBA ASRI - WAY TUBA ASRI
KEC. WAY TUBA

KAMPUNG : WAY TUBA ASRI

KECAMATAN : WAY TUBA

KABUPATEN : WAY KANAN

PROPINSI : LAMPUNG

GAMBAR

SITUASI
MEMANJANG

KONSULTAN PERENCANA
CV. TRIJAYA WASKITA

ENDAH PRAPTINI, ST
TEAM LEADER

DIGAMBAR

DIRENCANA

YOPI FAJRI
DRAFTER

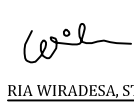
RIA WIRADESA, ST
TEAM LEADER

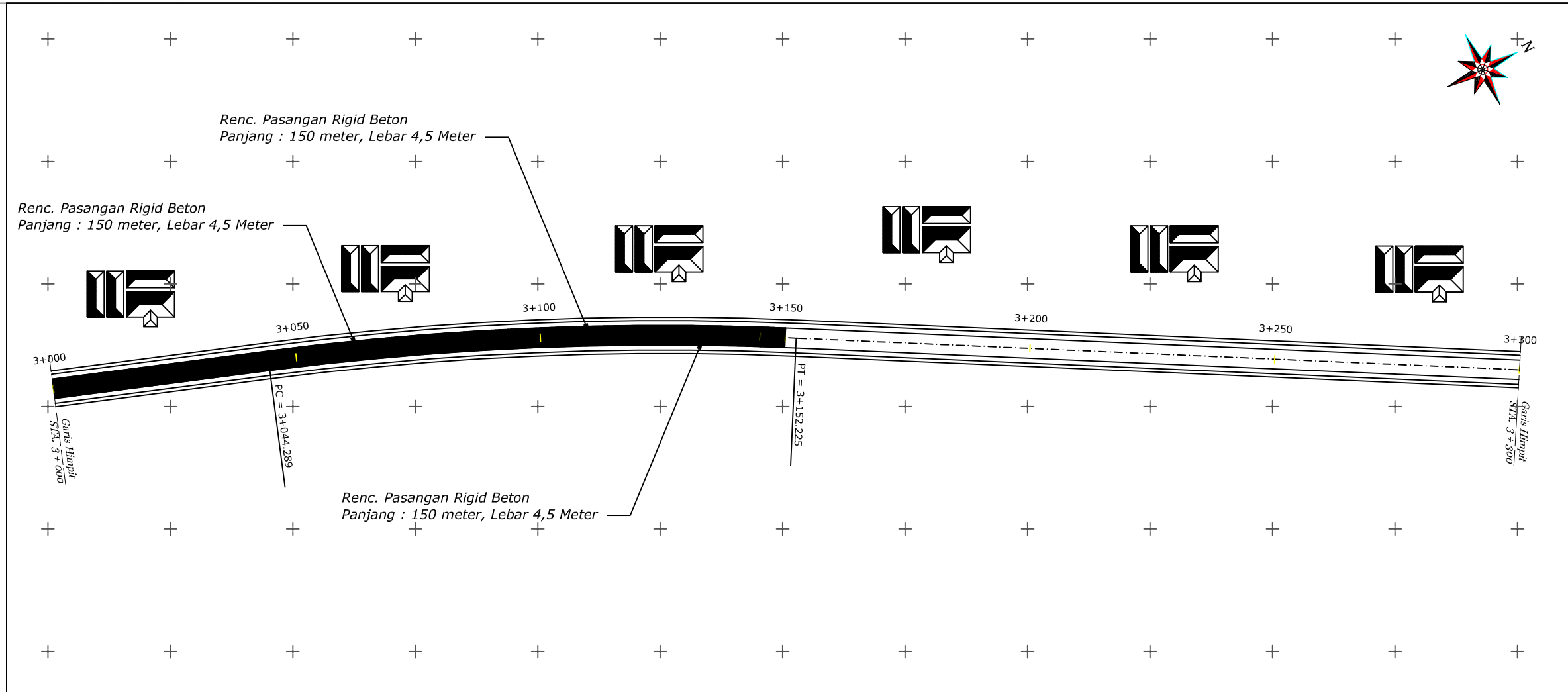

SKALA NO. LEMBAR JUMLAH LEMBAR

1 : 1.000
1 : 100



FINISHING LEVEL	99.017	98.973	98.929	98.885	98.840	98.796	98.752	FINISHING LEVEL
EXISTING LEVEL	98.985	98.941	98.897	98.853	98.808	98.764	98.720	EXISTING LEVEL
STA	3+000	3+050	3+100	3+150	3+200	3+250	3+300	STA

LEGENDA

-  = Pemukiman
-  = Gorong-gorong
-  = Jembatan

KEGIATAN

PEKERJAAN

PEMELIHARAAN JALAN SP. WAY TUBA ASRI - WAY TUBA ASRI
KEC. WAY TUBA

KAMPUNG : WAY TUBA ASRI

KECAMATAN : WAY TUBA

KABUPATEN : WAY KANAN

PROPINSI : LAMPUNG

GAMBAR

SITUASI
MEMANJANG

KONSULTAN PERENCANA
CV. TRIJAYA WASKITA



ENDAH PRAPTINI, ST
TEAM LEADER

DIGAMBAR

YOPI FAJRI
DRAFTER

DIRENCANA

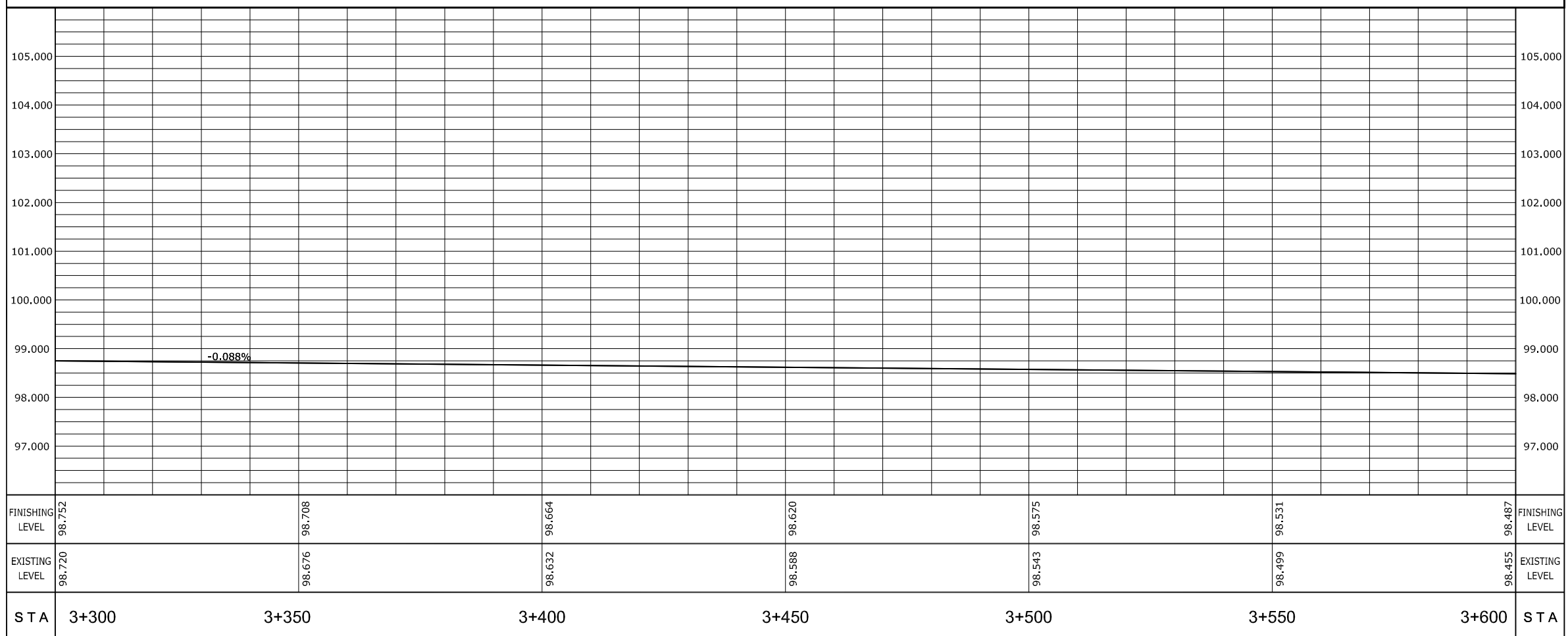
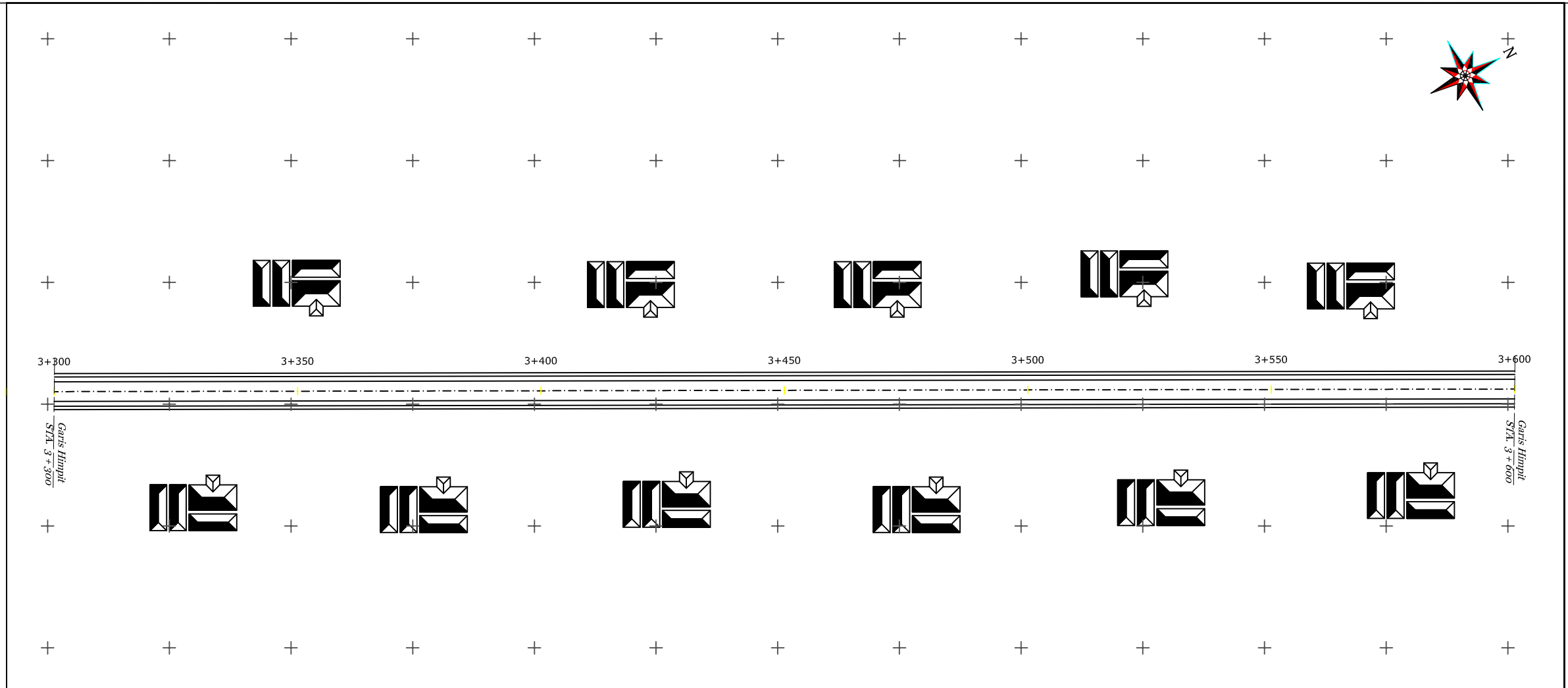
RIA WIRADESA, ST
TEAM LEADER



SKALA	NO. LEMBAR	JUMLAH LEMBAR
1 : 1.000 1 : 100	-	-

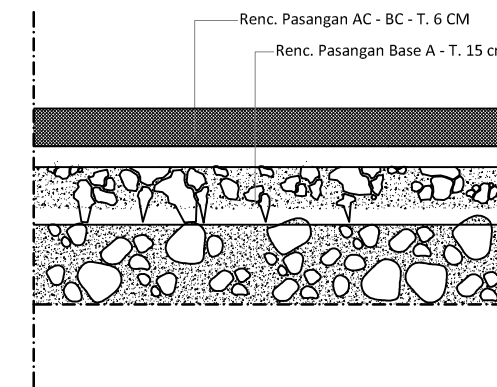
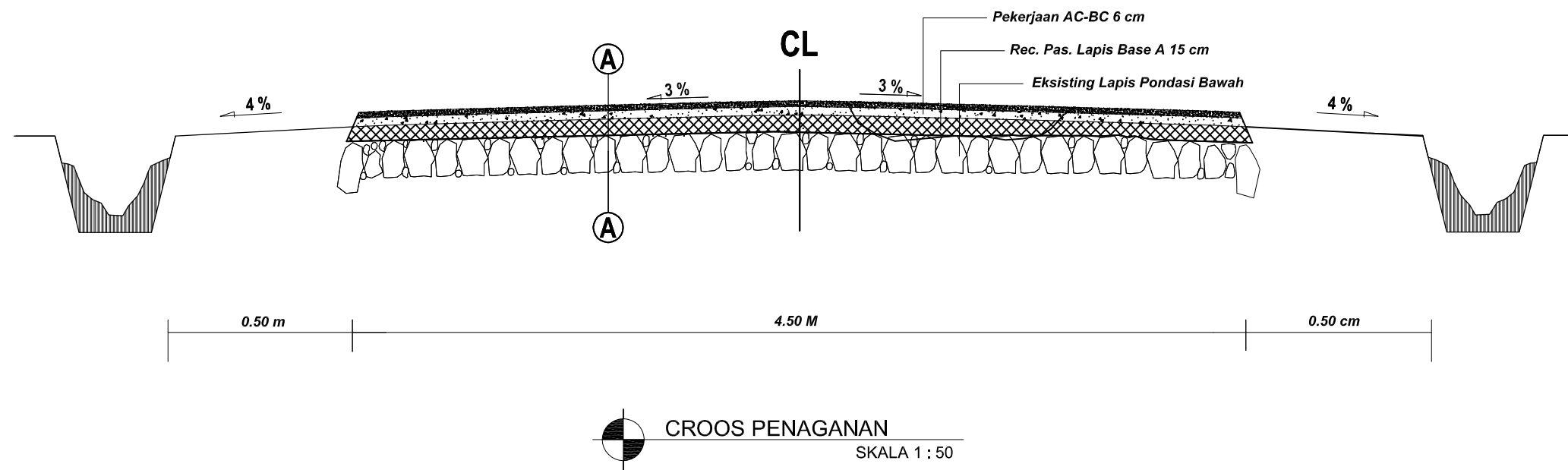
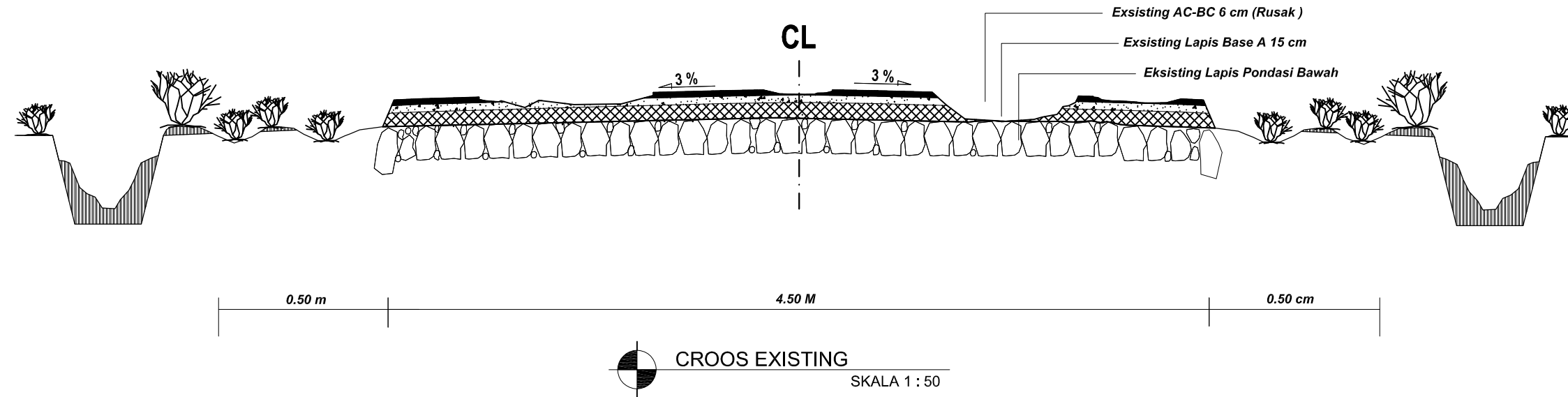

Detail Penanganan



LEGENDA

-  = Pemukiman
-  = Gorong-gorong
-  = Jembatan

KEGIATAN

PEKERJAAN

PEMELIHARAAN JALAN SP. WAY TUBA ASRI - WAY TUBA ASRI
KEC. WAY TUBA

KAMPUNG : WAY TUBA ASRI

KECAMATAN : WAY TUBA

KABUPATEN : WAY KANAN

PROPINSI : LAMPUNG

GAMBAR

SITUASI MEMANJANG

KONSULTAN PERENCANA

CV. TRIJAYA WASKITA

ENDAH PRAPTINI, ST
TEAM LEADER

DIGAMBAR





YOPI FAJRI
DRAFTER

DIRENCANA

RIA WIRADESA, ST
TEAM LEADER

SKALA	NO. LEMBAR	JUMLAH LEMBAR
1 : 1.000	-	-
1 : 100	-	-

LEGENDA

-  = Pemukiman
-  = Gorong-gorong
-  = Jembatan

KEGIATAN

PEKERJAAN

PEMELIHARAAN JALAN SP. WAY TUBA ASRI - WAY TUBA ASRI
KEC. WAY TUBA

KAMPUNG : WAY TUBA ASRI

KECAMATAN : WAY TUBA

KABUPATEN : WAY KANAN

PROPINSI : LAMPUNG

GAMBAR

SITUASI
MEMANJANG

KONSULTAN PERENCANA

CV. TRIJAYA WASKITA

 ENDAH PRAPTINI, ST
TEAM LEADER

DIGAMBAR



 YOPI FAJRI
DRAFTER

DIRENCANA

 RIA WIRADESA, ST
TEAM LEADER

SKALA	NO. LEMBAR	JUMLAH LEMBAR
1 : 1.000	-	-
1 : 100	-	-

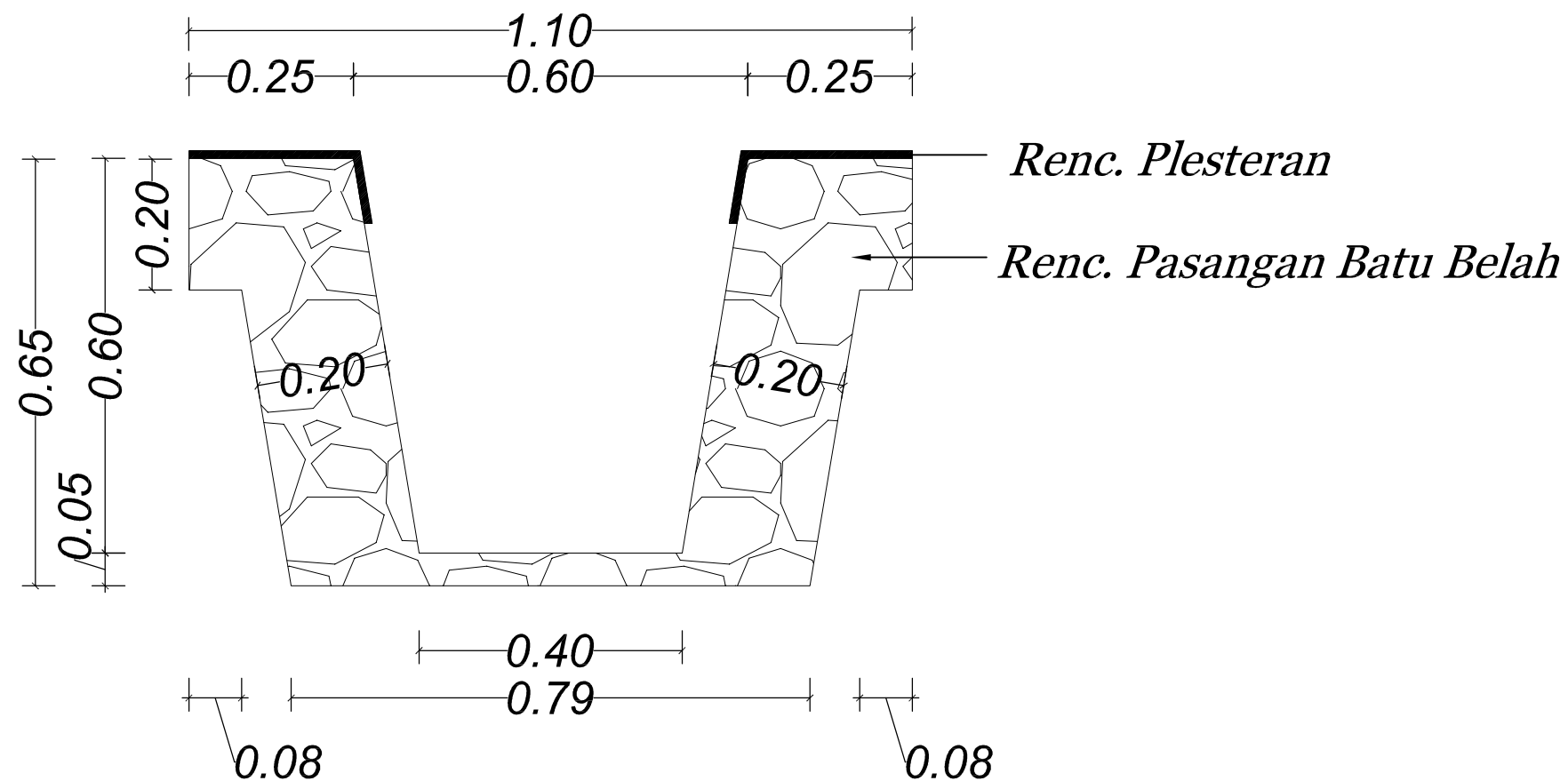
1 : 1.000
1 : 100



RENCANA PASANGAN SIRING

KANAN JALAN

STA 0+000 S/D 0+252

KIRI JALAN

STA 0+000 S/D 0+252

TOTAL PANJANG PENGANAN SIRING PASANG

504 METER

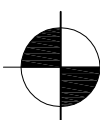



DETAIL SIRING PASANG TYPE 60/60

SKALA = 1 : 50

Detail Pasangan Rigid Beton

LEGENDA

-  = Pemukiman
-  = Gorong-gorong
-  = Jembatan

KEGIATAN

PEKERJAAN

PEMELIHARAAN JALAN SP. WAY TUBA ASRI - WAY TUBA ASRI
KEC. WAY TUBA

KAMPUNG : WAY TUBA ASRI

KECAMATAN : WAY TUBA

KABUPATEN : WAY KANAN

PROPINSI : LAMPUNG

GAMBAR

SITUASI
MEMANJANG

KONSULTAN PERENCANA
CV. TRIJAYA WASKITA

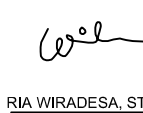

ENDAH PRAPTINI, ST
TEAM LEADER

DIGAMBAR

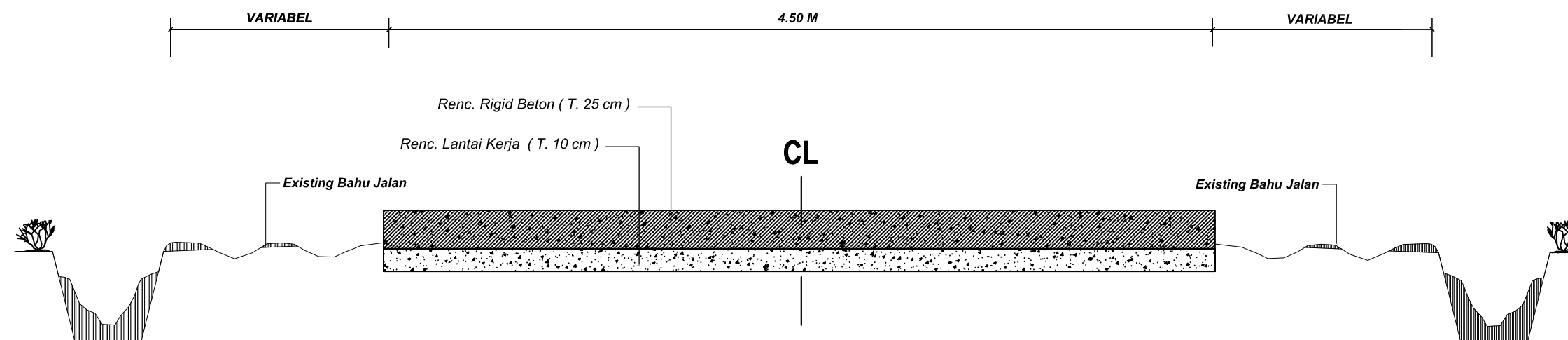
YOPI FAJRI
DRAFTER

DIRENCANA

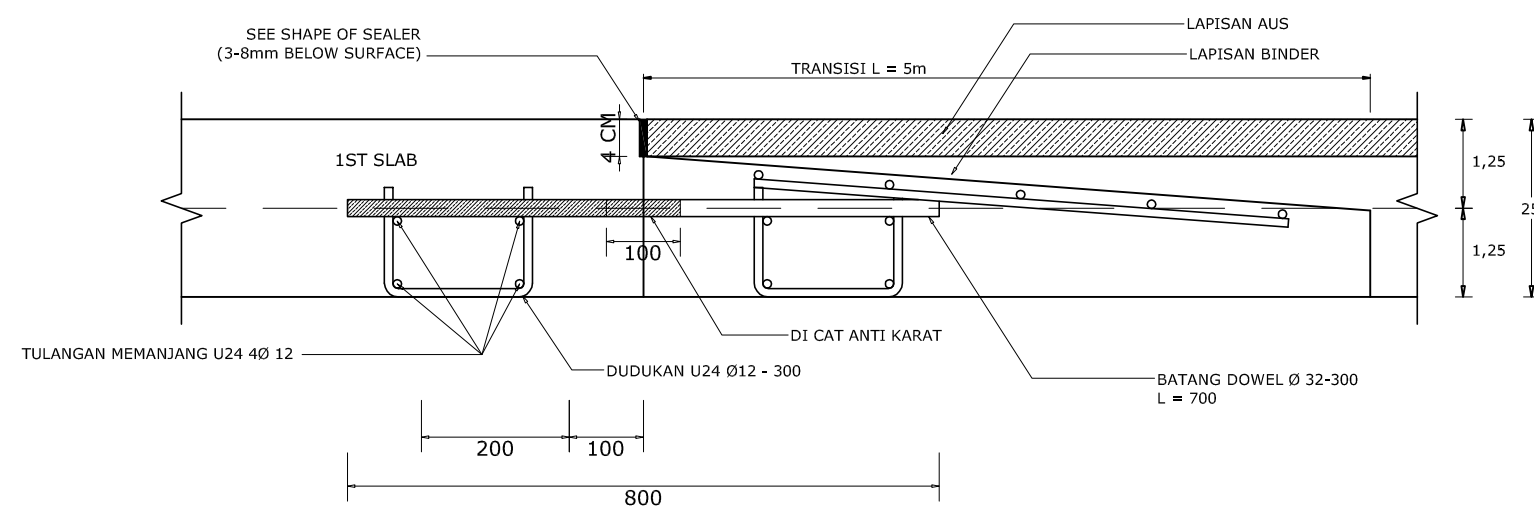
RIA WIRADESA, ST
TEAM LEADER



RENC. PENANGANAN TRANSISI
Scale: 1: 50



RENCANA PENANGANAN RIGID TYPE 1

STA 3 + 000 s/d 3 + 150



TOTAL RENCANA PASANGAN RIGID : 150 METER

TRANSISI STRUKTUR DENGAN PERKERASAN ASPAL
SKALA 1:10



SKALA	NO. LEMBAR	JUMLAH LEMBAR
1 : 1,000 1 : 100	-	-

LEGENDA

-  = Pemukiman
-  = Gorong-gorong
-  = Jembatan

KEGIATAN

PEKERJAAN

PEMELIHARAAN JALAN SP. WAY TUBA ASRI - WAY TUBA ASRI
KEC. WAY TUBA

KAMPUNG : WAY TUBA ASRI

KECAMATAN : WAY TUBA

KABUPATEN : WAY KANAN

PROPINSI : LAMPUNG

GAMBAR

SITUASI
MEMANJANG

KONSULTAN PERENCANA
CV. TRIJAYA WASKITA

ENDAH PRAPTINI, ST
 TEAM LEADER

DIGAMBAR

DIRENCANA

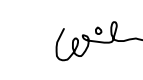

YOPI FAJRI
 DRAFTER

RIA WIRADESA, ST
 TEAM LEADER

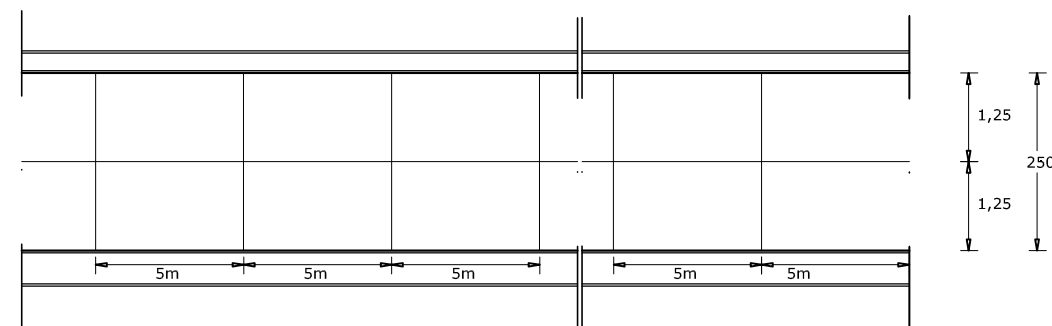
SKALA	NO. LEMBAR	JUMLAH LEMBAR
1 : 1.000	-	-
1 : 100	-	-

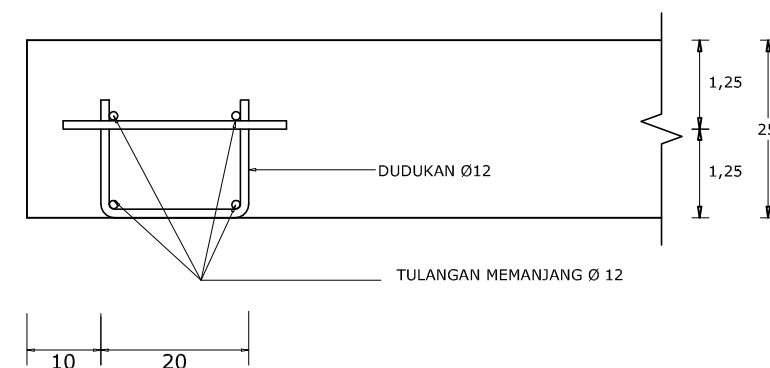

DENAH PEMBAGIAN SEGMENT
SKALA 1:500



PENULANGAN TEPI
SKALA 1:10

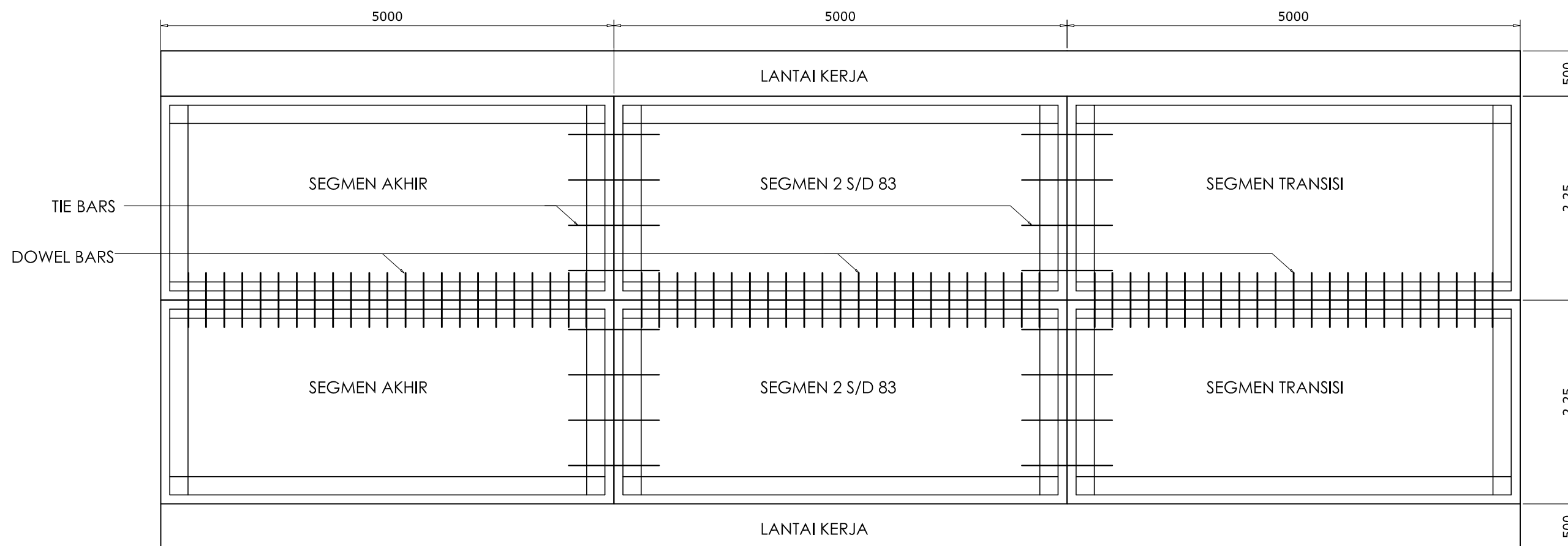

LAYOUT SEGMENT TIE BARS DAN DOWEL BARS

SKALA 1:50

LEGENDA

- = Pemukiman
- = Gorong-gorong
- = Jembatan

KEGIATAN

PEKERJAAN

PEMELIHARAAN JALAN SP. WAY TUBA ASRI - WAY TUBA ASRI
 KEC. WAY TUBA

KAMPUNG : WAY TUBA ASRI

KECAMATAN : WAY TUBA

KABUPATEN : WAY KANAN

PROPINSI : LAMPUNG

GAMBAR

SITUASI
 MEMANJANG

KONSULTAN PERENCANA

CV. TRIJAYA WASKITA

ENDAH PRAPTINI, ST
 TEAM LEADER

DIGAMBAR

YOPI FAJRI
 DRAFTER

DIRENCANA

RIA WIRADESA, ST
 TEAM LEADER

SKALA NO. LEMBAR JUMLAH LEMBAR

1 : 1.000
 1 : 100

-

-

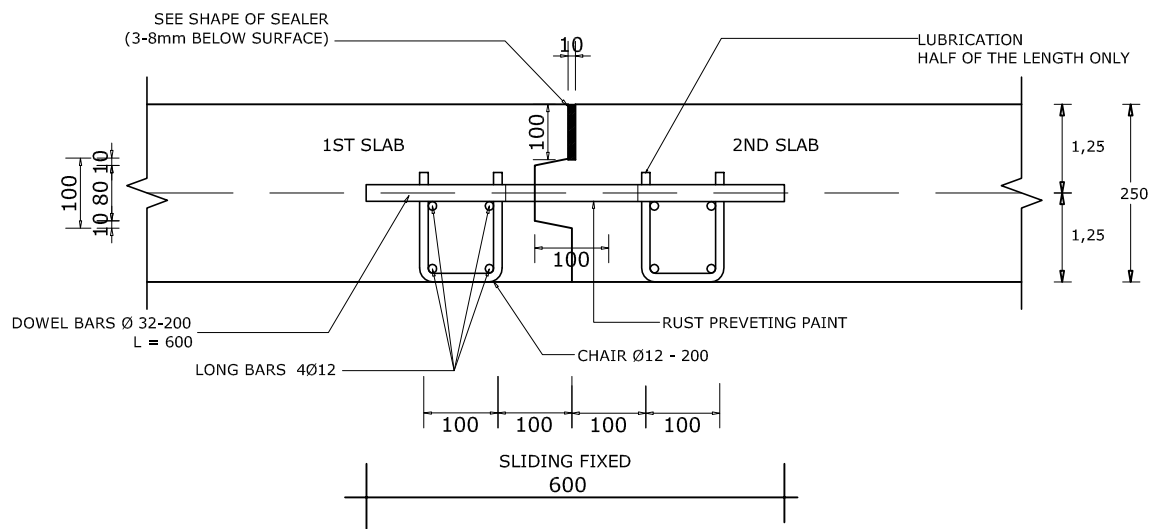

CONSTRUCTION JOINT MELINTANG
 SKALA 1:10

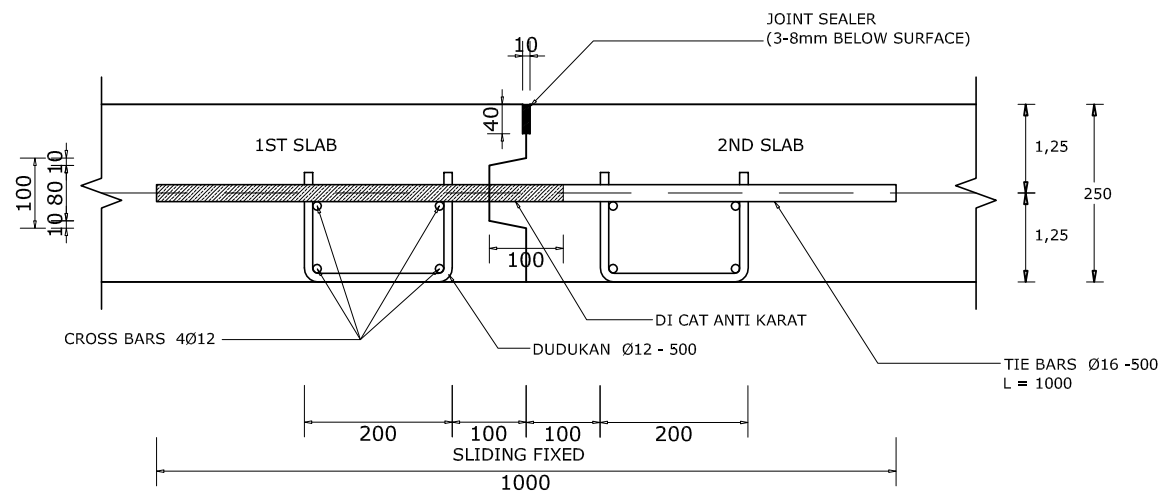

CONSTRUCTION JOINT MEMANJANG
 SKALA 1:10

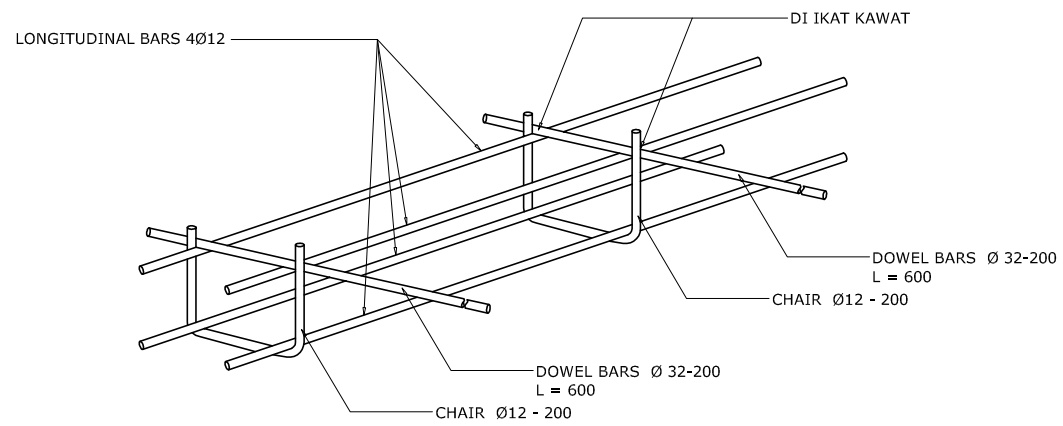

SUPPORT METHOD FOR DOWEL
 SKALA 1:10

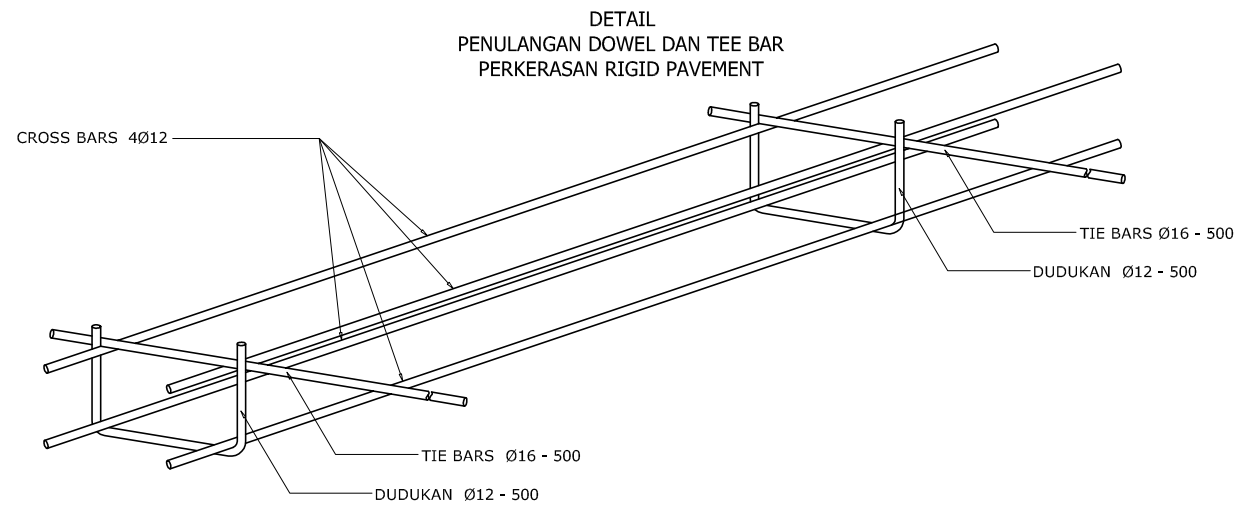

SUPPORT METHOD FOR TIE BARS
 SKALA 1:10

DETAIL
 PENULANGAN DOWEL DAN TEE BAR
 PERKERASAN RIGID PAVEMENT